

- IP68 Mated Or Unmated
- Metal / Plastic Version
- Push Pull Quick Mating Mechanism
- Blind Mating With Audible Feedback
- Power, Data / Signal, Hybrid
- Flammability UL 94V-0 & UV Resistant
- UL Certified



Contents

- 1** Product Selection Guide
- 11** Service Markets & Applications
- 15** Our Service
- 21** Markets / Applications
- 24** Product Range Overview
- 25** HS-Lok Connector
- 27** Assembly Instruction
- 28** Cable List
- 31** UL Style
- 37** FAQ and Lexicon



IP68



Push Pull
Mechanism



Blind
Mating



Audible
Feedback



UL
Recognized



UV
Resistant



UL2238 + 50e

Product Selection Guide

Circular (Ceres, X-Lok, M)

	Mating Style						Materials	No. of Contacts	Contacts		Operating Voltage (AC/DC)	Nominal Current	Applicable Wires (AWG)	Mating Cycles (Pin Contact)	High Speed		Salt Spray (Connector, Mated)
	2 Points Lock	3 Points Lock	Push Lock	Push Pull	Screw Thread	Others			Gold Plated	Silver Plated					Cat. 5e	Cat. 6A	
Ceres Series																	
Mini	•				•		B	2-6	•		250V	2A-5A	26-24	2,000			500h
Standard	•				•		B	2-12	•		250-600V	2A-10A 5A+2A 10A+5A	26-20	2,000			500h
Middle	•	•			•		P	2-18	•	•	250-600V	2A-20A 5A+2A 10A+2A 10A+5A	24-14	2,000			500h
Large	•				•		B	2-22	•	•	250-600V	2A-20A 20A+2A 20A+5A	26-16	2,000			500h
Macro	•						P	31	•		200V	5A	26	2,000			500h
PLD			•				P	2-4	•		250V	5A	26-20	2,000			500h
MAB	•						P	4	•		250V	10A	20	2,000			500h
GBD		•					P	8	•		250V	10A+5A	20-24	2,000			500h
X-LOK Series																	
Mini / LED			•				B	2-33	•		30-630V	0.5A-16A	32-14	1,000	•	•	1000h
Standard			•				P	2-8	•		300-600V	5A-10A 10A+5A	26-16	1,000			1000h
Middle			•				P	2-12	•	•	300-600V	5A-20A 10A+5A	26-12	1,000			1000h
Large			•				B	2-100	•	•	60V (0.5A) 300-600V	0.5A-20A 20A+5A 50A 50A+5A	32-6	1,000			1000h
Macro			•				P	4-31	•	•	300-600V	5A 50A+5A 80A+5A	22-2	1,000			1000h
M Series																	
M5					•		M	3-6	•		60V	1A	28-26	1,000			48h
Guided M8 / LED					•	Snap-in	B	2-6	•		30-60V	1.5A-3A 3A+1.5A	24-22	1,000			48h
M8 / LED					•	Snap-in	B	3-13	•		30-60V	0.5A-3A	32-22	1,000			48h
M10.5					•		M	2-5	•		30V	2A	24	1,000			48h
M12 A / LED			•	•			B	3-28	•		30-250V	0.5A-4A	30-22	1,000	•		48h
M12 B / LED			•	•			B	5	•		60V	4A	26-22	1,000			48h
M12 D / LED			•	•			B	4	•		250V	4A	26-22	1,000	•		48h
M12 I			•	•			B	5	•		60V	4A	22	1,000			48h
M12 K / LED			•	•			B	3-5	•		630V	12A, 16A	14	1,000			48h
M12 L / LED			•	•			B	2-5	•		63V	16A	14	1,000			48h
M12 M / LED			•	•			B	3-6	•		630V	8A	16	1,000			48h
M12 S / LED			•	•			B	3-4	•		630V	12A	16	1,000			48h
M12 T / LED			•	•			B	2-4	•		63V	12A	16	1,000			48h
M12 X			•	•			M	8	•		30-60V	0.5A	26	1,000		•	48h
M12 Y			•	•			B	8	•		60V	0.5A / 6A	20, 26	1,000			48h
M23			•	•			M	6	•		600V	28A	14-12	1,000			48h

Remarks:
Materials: P (Plastic), M (Metal), B (Both)

Product Selection Guide

	(R0) Receptacle						(FI) Field Installable						OC	UV Resistant	UL 94V-0	Vibration	EMI Option	ROHS 2.0 & REACH	Standard / Compliant	Certifications	Operating Temperature & IP Rating	
	Solder	Crimp	SMT	PCB 180	PCB 90	RW	RC	Solder	Crimp	Screw In	Push In	IDC										
Ceres Series																						
Mini	•			•			•	•					•			(2)	•	•				
Standard	•			•	•		•	•					•			(2)	•	•		UL1977	◦ RO : -40°C - 105°C, IP67 (Unmated)	
Middle	•			•			•	•					•			(2)	•	•		UL1977	◦ RW : -20°C - 85°C, IP67 (Unmated)	
Large	•			•			•	•	•				•			(2)	•	•		UL1977	◦ OC : -20°C - 85°C, IP67 (Mated)	
Macro	•			•									•			(2)	•	•		UL1977	◦ FI : -40°C - 105°C, IP67 (Mated)	
PLD	•							•					•			(2)	•	•				
MAB													•			(2)	•	•				
GBD													•			(2)	•	•				
X-LOK Series																						
Mini / LED	•			•	•			•	•	•	•		•			(2)	•	•				
Standard	•			•				•	•	•	•		•			(2)	•	•				
Middle	•			•				•	•	•	•		•			(2)	•	•		CSA, UL1977, UL2238, UL50e	◦ RO & RW : -40°C - 105°C, IP68 (Unmated)	
Large	•			•				•	•	•	•		•			(2)	•	•				◦ OC & FI : -40°C ~ 105°C, IP68 (Mated)
Macro	•	•		•					•	•			•			(2)	•	•				
M Series																						
M5	•			•	•	•							•			(1)		•	IEC 61076-2-105			
Guided M8 / LED	•			•	•	•		•	•	•		•	•			(1)	•	•				
M8 / LED	•			•	•	•		•	•	•		•	•			(1)	•	•	IEC 61076-2-104	UL1977, UL2238		
M10.5	•					•							•	94-HB		(1)		•				
M12 A / LED	•			•	•	•		•	•	•	•	•	•			(1)	•	•	IEC 61076-2-101	UL1977, UL2238, UL1863	◦ RO : -40°C ~ 105°C, IP67 (Mated / Unmated), IP68 (Unmated), IP69K (Mated)	
M12 B / LED	•			•	•	•		•	•	•	•	•	•			(1)	•	•	IEC 61076-2-101	UL1977, UL2238		
M12 D / LED	•			•	•	•		•	•	•	•	•	•			(1)	•	•	IEC 61076-2-101	UL1977, UL2238, UL1863	◦ RW : -20°C ~ 85°C, IP67 (Mated / Unmated), IP68 (Unmated), IP69K (Mated)	
M12 I	•			•				•					•	94-HB		(1)		•				
M12 K / LED	•			•	•	•		•	•	•		•	•			(1)	•	•	IEC 61076-2-111	UL1977, UL2237		
M12 L / LED	•			•	•	•		•	•	•		•	•			(1)	•	•	IEC 61076-2-111	UL1977, UL2238	◦ OC : -20°C ~ 85°C, IP67 / IP68 (Mated)	
M12 M / LED	•			•	•	•		•	•	•		•	•			(1)	•	•	IEC 61076-2-111			
M12 S / LED	•			•	•	•		•	•	•		•	•			(1)	•	•	IEC 61076-2-111	UL1977, UL2237	◦ FI : -40°C ~ 105°C, IP67 / IP68 (Mated)	
M12 T / LED	•			•	•	•		•	•	•		•	•			(1)	•	•	IEC 61076-2-111	UL1977, UL2238		
M12 X				•	•	•		•	•			•	•			(1)	•	•	IEC 61076-2-109	UL1863		
M12 Y				•	•	•		•				•	•			(1)	•	•	IEC 61076-2-109	UL1863		
M23		•						•				•	•			(1)	•	•				

Remarks:
Assemble Style: **RO** (Receptacle), **RW** (Receptacle With Wires), **RC** (Receptacle With Overmolded Cable), **OC** (Overmolded With Cables), **FI** (Field Installable)
Vibration: (1) 10-500 Hz @Amplitude 0.35mm; (2) 10-55Hz @Amplitude 1.52mm
Operation Temperature & IP Rating: **RO** (Receptacle), **RW** (Receptacle With Wires), **OC** (Overmolded With Cables), **FI** (Field Installable)

Product Selection Guide

Circular (FLOS, Power, RBL)

	Mating Style						Materials	No. of Contacts	Contacts		Operating Voltage (AC/DC)	Nominal Current	Applicable Wires (AWG)	Mating Cycles (Pin Contact)	Salt Spray (Connector, Mated)	(R0) Receptacle		
	2 Points Lock	3 Points Lock	Push Lock	Push Pull	Screw Thread	Others			Gold Plated	Silver Plated						Solder	Crimp	Screw In
FLOS Series																		
B				•			M	2-32	•		160-700V	1.5A-25A	28-16	5,000	144h	•		
K				•			M	2-32	•		160-700V	1.5A-25A	28-16	5,000	144h	•		
K (FLOS+)				•			M	2-32	•		160-700V	1.5A-25A	28-16	5,000	1000h	•		
C				•			M	2-19	•		160-700V	1.5A-20A	28-16	3,000	144h	•		
S				•			M	1	•		260-1000V	15A	28-16	3,000	144h	•		
Y				•		Break Away	M	2-26	•		260-1000V	5A-14A	28-16	5,000	96h	•		
P				•			P	2-14	•		200-400V	2A-10A	28-16	2,000		•		
N				•			M	2-19	•		200-800V	5A-22A	28-16	3,000	144h	•		
Power Series																		
PWE					•		P	5-7	•		277V	8A	20-17	500	500h	•		
PWF					•		P	2-4	•		277V	12A	18-15	500	500h	•		
PWG					•		P	4	•		277V	16A	18-14	500	500h			•
PWC	•	•					P	3	•		277V	20A	14-12	500	500h	•		
PWCU	•	•					P	4 & 12	•		277V	20A+2A	14-12, 24-22	500	500h	•		
PWH		•			•		P	3, 5	•		660V (AC) 1000V (DC)	25A	12	500	500h		•	•
PWL		•					P	3	•		300V	30A	14-8	500	500h			•
PWM		•					P	2	•		600V	50A	9-8	500	720h	•		
PWMU		•					P	2+2, 2+4	•		600V	50A+2A	9-8, 22-20	500	720h	•		
PWN		•					P	2	•		600V	70A	8-6	500	720h	•		
PWNU		•					P	2+2, 2+4	•		600V	70A + 2A	8-6, 22-20	500	720h	•		
PWPP		•					P	2 & 3	•		600V	80A	4	500	720h		•	
PWPD		•					P	2+2, 2+4, 3+2, 3+4	•		600V	80A+5A	4, 20	500	720h		•	
PWX		•					P	9 (30A) 14 (30A+5A) 5 (50A) 12 (50A+5A) 4 (80A) 7 (80A+5A)	•		300-600V	30A, 30A+5A 50A, 50A+5A 80A, 80A+5A	22-20, 14-8, 9-8, 4	500	720h		•	
RBL Series																		
Middle			With Latch				P	2-9	•		300V	5A-10A 10A+5A	20-16	250	48h			
Large			With Latch				P	2-18	•		300V	5A-20A 20A+5A	24-12	250	48h			

Remarks:
Materials: P (Plastic), M (Metal)
Assemble Style: R0 (Receptacle)

Product Selection Guide

	(R0) Receptacle		RW	(FI) Field Installable			OC	UV Resistant	UL 94V-0	Vibration	EMI Option	ROHS 2.0 & REACH	Certifications	IP Rating	Operating Temperature	
	PCB 180	PCB 90		Solder	Crimp	Screw In										
FLOS Series																
B	•	•		•	•				(2)	•	•			IP50 (Mated)	<ul style="list-style-type: none"> ◦ RO: -40°C - 125°C ◦ OC: -20°C - 85°C ◦ FI: -40°C - 125°C 	
K	•	•		•	•				(2)	•	•			IP68 (Mated)		
K (FLOS+)	•	•		•	•				(2)	•	•			RO : IP68 (Unmated) OC : IP68 (Mated) FI : IP68 (Mated)		
C	•	•		•	•				(2)	•	•			IP68 (Mated)		
S	•	•		•	•				(2)	•	•			IP50 (Mated)		
Y	•	•		•	•				(2)	•	•			IP68 (Mated)		
P	•	•		•	•		•		(2)		•			IP50 / IP66 (Mated)		
N	•	•		•	•				(2)	•	•			IP68 (Mated)		
Power Series																
PWE				•				94-HB	(2)		•	UL1977		IP67 / IP68	<ul style="list-style-type: none"> ◦ RO: -40°C - 105°C ◦ OC: -20°C ~ 80°C ◦ FI: -40°C ~ 105°C 	
PWF				•				94-HB	(2)		•	UL1977, TUV		IP67 / IP68		
PWG						•			(2)		•	UL1977		IP67 / IP68		
PWC				•		•	•		(2)		•	UL1977, TUV/UL2238		IP67 / IP68		
PWCU				•			•		(2)		•	UL1977, TUV		IP67 / IP68		
PWH					•	•	•		(2)		•	UL1977, UL6703A, TUV		IP67 / IP68		
PWL				•		•	•		(2)		•	UL2238/UL1977		IP67 / IP68		
PWM						•	•		(2)		•	UL1977		IP67 (Mated)		
PWMIU						•	•		(2)		•	UL1977		IP67 (Mated)		
PWNI						•	•		(2)		•	UL1977		IP67 (Mated)		
PWNU						•	•		(2)		•	UL1977		IP67 (Mated)		
PWP					•		•		(2)		•	UL1977		IP67 (Mated)		
PWPD					•		•		(2)		•	UL1977		IP67 (Mated)		
PWX					•		•				•	UL1977		IP69K (Mated)		
RBL Series																
Middle			•		•		•	•	(2)		•	UL1977		RW : IP68 (Unmated) OC : IP68 (Mated) FI : IP67 (Mated)		<ul style="list-style-type: none"> ◦ RW: -40°C ~ 105°C ◦ OC: -20°C ~ 80°C ◦ Data: -20°C ~ 80°C ◦ Power: -20°C ~ 105°C ◦ Hybrid: -40°C ~ 105°C ◦ FI: -40°C ~ 105°C
Large			•		•		•	•	(2)		•					

Remarks:

Assemble Style: **RO** (Receptacle), **RW** (Receptacle With Wires), **OC** (Overmolded With Cables), **FI** (Field Installable)

Vibration: **(2)** 10-55Hz @Amplitude 1.52mm

Operation Temperature & IP Rating: **RO** (Receptacle), **RW** (Receptacle With Wires), **OC** (Overmolded With Cables), **FI** (Field Installable)

Product Selection Guide

Circular (HS-Lok, NMEA 2000, Mini, Heavy Duty Shielded)

	Mating Style		Materials	No. of Contacts	Contacts Gold Plated	Operating Voltage (AC/DC)	Nominal Current	Applicable Wires (AWG)	Mating Cycles (Pin Contact)	Salt Spray (Connector, Mated)	(R0) Receptacle			RW
	Push Pull	Screw Thread									Solder	PCB 180	PCB 90	
HS-Lok Series														
Q8	•		B	2-6	•	100V (DC), 300V, 300V (AC) + 100V (DC)	2A 5A 5A+2A	24-20	2,000	500h	•			
NMEA 2000														
Lite (Micro)	•	•	B	5	•	60V	4A	16*1P+20*1P 18*1P+22*1P 22*1P+24*1P	Push Pull 500, Screw Thread 1,000	Metal: 48h Plastic: 1,000h	•	•	•	•
Heavy (Mini)		•	M	4-5	•	600V	8A	15*1P+18*1P 16*1P+18*1P	1,000		•	•		
7/8" Mini														
7/8" Mini		•	M	2, 2+PE, 4, 4+PE, 6	•	600V	8A-13A	16	1,000	48h	•	•		•
Heavy Duty Shielded														
Heavy Duty Shielded		*	M	2-14	•	50-300V	5A-40A	22-8	1,000	48h / 500h	•			

Remarks:

Materials: M (Metal), B (Both)

Assemble Style: R0 (Receptacle), RW (Receptacle With Wires)

Product Selection Guide

	(FI) Field Installable				OC	UV Resistant	UL 94V-0	Vibration	EMI Option	ROHS 2.0 & REACH	Certifications	IP Rating	Operating Temperature
	Solder	Crimp	Screw In	Push In									
HS-Lok Series													
Q8	•				•	•		(2)		•	UL2238, UL50e	RO: IP68 (Unmated) OC: IP68 (Mated) FI: IP68 (Mated)	◦ RO: -40°C - 105°C ◦ OC: -40°C - 105°C ◦ FI: -40°C - 105°C
NMEA 2000													
Lite (Micro)			•	•	•			(1)	•	•	NMEA 2000	RO: IP68 (Unmated) RW: IP68 (Unmated) OC: IP68 (Mated) FI: IP67 (Mated)	◦ RO: -40°C - 105°C ◦ RW: -20°C - 85°C ◦ OC: -20°C - 85°C ◦ FI: -40°C - 105°C
Heavy (Mini)			•	•	•		94-HB	(1)	•	•	NMEA 2000		
7/8" Mini													
7/8" Mini	•	•	•		•			(1)		•		RO: IP68 (Unmated) RW: IP68 (Unmated) OC: IP68 (Mated) FI: IP67 (Mated)	◦ RO: -40°C - 105°C ◦ OC: -40°C - 105°C ◦ FI: -40°C - 105°C
Heavy Duty Shielded													
Heavy Duty Shielded	•				•	•	94-HB	(1)	•	•		RO: IP68 (Unmated) OC: IP68 (Mated) FI: IP68 (Mated)	◦ RO: -40°C - 105°C ◦ RW: -20°C - 85°C ◦ OC: -20°C - 85°C ◦ FI: -40°C - 105°C

Remarks:

Assemble Style: **OC** (Overmolded With Cables), **FI** (Field Installable)

Vibration: **(1)** 10-500 Hz @Amplitude 0.35mm; **(2)** 10-55Hz @Amplitude 1.52mm

Operation Temperature & IP Rating: **RO** (Receptacle), **RW** (Receptacle With Wires), **OC** (Overmolded With Cables), **FI** (Field Installable)

Product Selection Guide

Other IO (RJ45, USB, D-Sub, SSL, HDMI, DVI)

	Mating Style					Materials	No. of Contacts	Gold Plated	Operating Voltage (AC/DC)	Nominal Current	Applicable Wires (AWG)	Mating Cycles (Pin Contact)	High Speed		
	2 Points Lock	3 Points Lock	Push Lock	Screw Thread	Others								Cat. 5e	Cat. 6A	USB 2.0
RJ45 Series															
Middle		•		•		B	8		44-57V (DC)	Max. 1.5A	Cat. 6A: 26 / Cat. 5e: 24	750	•	•	
Large / I-Adaptor	•	•		•		P	8		44-57V (DC)	Max. 1.5A	24	750	•		
ODVA	•					B	8		44-57V (DC)	Max. 1.5A	Cat. 6A: 26 / Cat. 5e: 24	750	•	•	
Self-Closing Cover						P	8		44-57V (DC)	Max. 1.5A		750	•	•	
USB Series															
Mini USB Type B				•		P		•	30V	1.5A	28*1P + 28*3C	5,000		•	
Type A	•			•		B		•	30V	USB 2.0: 1.5A USB 3.2 Gen1: 1A	28*1P + 24*2C	1,500		•	
Type B	•			•		B		•	30V	USB 2.0: 1.5A	28*1P + 24*2C	1,500		•	
Micro USB Swift						M		•	30V (AC) 5V (DC)	1 & 5 Pin: 1.8A 2, 3 & 4 Pin: 1A		10,000		•	
Micro USB Swift-MU					Snap-in	P		•	30V (AC) 5V (DC)	1 & 5 Pin: 1.8A 2, 3 & 4 Pin: 1A	28	10,000		•	
Type C Swift-LP						M		•	30V (DC)	Up To 5A	32*1P + 24*1C + 28*1D	10,000			
Type C Swift-LA					Snap-in	P		•	30V (DC)	Up To 3A	32*1P + 24*1C + 28*1D	10,000		•	
Type C Swift-GG				•		B		•	30V (DC)	Up To 5A	32*1P + 24*1C + 28*1D	10,000			
Type C Swift-XL				•		P		•	30V (DC)	Up To 3A	32*1P + 24*1C + 28*1D	10,000			
D-SUB Series															
Standard				•	Automated Latch	M	9, 15, 25, 37, 50*	•	125V (DC)	5A	24	500			
High Density				•	Automated Latch	M	15, 26, 44, 62*, 78*	•	125V (DC)	2A	26	500			
SSL Series															
SSL1.1				•		P	2-6	•	100V	3A	22	100			
SSL1.2				•		P	2-4	•	Wire: 250V Flat Cable: 300V	5A	22-18	Wire: 30 Flat Cable: 100			
HDMI Series															
Circular				•		P	19	•	30V (AC)	0.5A	26	500			
Rectangular				•	With Latch	P	19	•	30V (AC)	0.5A	26	500			
Mini-HDMI				•		P	19	•	30V (AC)	0.5A	30	500			
DVI Series															
DDD						M	25	•	40V (AC)	1.5A	28	100			
DDS						M	19	•	40V (AC)	1.5A	28	100			
DID						M	29	•	40V (AC)	1.5A	28	100			
DIS						M	23	•	40V (AC)	1.5A	28	100			

Remarks:
Materials: P (Plastic), M (Metal), B (Both)

Product Selection Guide

	High Speed		Salt Spray (Connector, Mated)	R0	RW	RP	OC	FI	UV Resistant	UL 94V-0	Vibration	EMI Option	ROHS 2.0 & REACH	Standard / Compliant / Certifications	Operating Temperature & IP Rating
	USB 3.2 Gen1	USB 3.2 Gen2													
RJ45 Series															
Middle			48h	PCB 90 & 180, Jack 90 & 180		•	•	•	•	•	(2)	•	•	TIA/EIA-568, IEC 60603-7	◦ RO : -40°C - 105°C, IP67 (Unmated & Mated)
Large / I-Adaptor			48h	PCB180, Jack 90 & 180		•	•	•	•	•	(2)	•	•	TIA/EIA-568, IEC 60603-7	◦ RP : -20°C - 85°C, IP67 (Unmated & Mated)
ODVA			48h	Jack 180		•	•	•	•	•	(2)	•	•	TIA/EIA-568, IEC 60603-7	◦ OC : -20°C - 85°C, IP67 (Mated) ◦ FI : -40°C - 105°C, IP67 (Mated)
Self-Closing Cover			48h	•					•	•	(2)	•	•	TIA/EIA-568, IEC 60603-7	-40°C - 105°C, IP67 (Unmated)
USB Series															
Mini USB Type B			48h	•	•	•	•	•		94V-HB	(2)	•	•		◦ RO : -40°C - 105°C, IP67 (Unmated)
Type A	•		48h	Type 1 & 2, Jack, PCB 180	•	•	•	Solder		•	(2)	•	•		◦ RW : -20°C - 85°C, IP67 (Unmated) ◦ OC : -20°C - 85°C, IP67P (Mated)
Type B	•		48h	Type 1 & 2, Jack, PCB 180	•	•	•	Solder		•	(2)	•	•		◦ FI : -40°C - 105°C, IP67 (Mated)
Micro USB Swift			48h	•						•	(2)	•	•		-30°C - 80°C, IP67/IP68 (Unmated)
Micro USB Swift-MU			48h	•			•			•	(2)	•	•		-40°C - 80°C, IP67 (Mated)
Type C Swift-LP		•	48h	•						•	(2)	•	•		-40°C - 85°C, IP67 (Unmated)
Type C Swift-LA	•		48h	•			•			•	(2)	•	•		◦ RO : -40°C - 85°C, IP68 (Unmated) ◦ OC : -20°C - 85°C, IP67 (Mated)
Type C Swift-GG	•	•	48h	•			•			•	(2)	•	•		◦ RO : -40°C - 85°C, IP67 (Unmated) ◦ OC : -20°C - 85°C, IP67 (Mated)
Type C Swift-XL	•		48h	•			•			•	(2)	•	•		◦ OC : -20°C - 85°C, IP68 (Mated)
D-SUB Series															
Standard			8h	Solder, PCB 90& 180			•	Solder, Crimp			(2)	•	•		◦ RO : -40°C - 105°C, IP68 (Unmated) ◦ OC : -20°C - 85°C, IP67P (Mated)
High Density			8h	Solder, PCB 90& 180			•	Solder, Crimp			(2)	•	•		◦ FI : -40°C - 105°C, IP67 (Mated)
SSL Series															
SSL1.1				•			•			•	(2)		•	CSA C22.2, UL1977	-40°C - 105°C, Non-IP
SSL1.2				•			•	•	•	•	(2)		•	CSA C22.2, UL1977, cUL UL2238+UL50e	-40°C - 105°C, IP68 (Mated)
HDMI Series															
Circular			48h	•			•			94V-HB	(2)	•	•		◦ RO : -20°C - 85°C, IP67 (Unmated)
Rectangular			48h	•			•			94V-1	(2)	•	•		◦ OC : -20°C - 85°C, IP67P (Mated)
Mini-HDMI			48h	•			•			•	(2)	•	•		
DVI Series															
DDD			8h	•			•				(2)		•		
DDS			8h	•			•				(2)		•		◦ RO : -40°C - 105°C, IP68 (Unmated)
DID			8h	•			•				(2)		•		◦ OC : -20°C - 85°C, IP67P (Mated)
DIS			8h	•			•				(2)		•		

Remarks:
Assemble Style: **RO** (Receptacle), **RW** (Receptacle With Wires), **RP** (Receptacle With Pigtail), **OC** (Overmolded With Cables), **FI** (Field Installable)
Vibration: (2) 10-55Hz @Amplitude 1.52mm
Operation Temperature & IP Rating: **RO** (Receptacle), **RW** (Receptacle With Wires), **RP** (Receptacle With Pigtail), **OC** (Overmolded With Cables), **FI** (Field Installable)

Product Selection Guide

Other IO (Fiber, RF)

	Mating Style		Materials	No. of Contacts	Gold Plated	Operating Voltage (AC/DC)	Applicable Wires (AWG)	Mating Cycles (Pin Contact)	Salt Spray (Connector, Mated)	RO
	3 Points Lock	Screw Thread								
Fiber Optic Series										
LC	•								48h	•
SC	•								48h	•
RF Series										
SMA Type		•	M	1	•	335 Volts RMS At Sea Level	1.13mm, 1.32mm, 1.37mm, RG178	500	48h	•
N Type		•	M	1	•	1,000 Volts RMS At Sea Level	1.13mm, 1.32mm, 1.37mm, RG142, RG178, G58 A/U	500	48h	•

Other (ZConnect, Cable Joiner, Cable Gland, Pressure Relief Vent, LED)

	Mating Style			Materials	No. of Contacts	Contacts				Operating Voltage (AC/DC)	Nominal Current	Applicable Wires (AWG)	Salt Spray (Connector, Mated)
	Push Lock With Latch	Screw Thread	Others			Gold Plated	Nickel Plated	Thermo plastic	SUS316L				
ZConnect Series													
FPC / FFC / WTB			Quick Plug	B	46, 36, 20, 18, 12	•				120V	1A		48h
Cable Joiner Series													
M20		•		P	None, 4	•					10A	22-16	
M32	•			P	None, 4	•					15A-30A	16-10	
FICXI Tube (11)		•		P	2-5		•			450V (Non-UL) 600V (UL)	16A-30A	20-12	
FICXI Tube (12)		•		P	2-5		•			450V (Non-UL) 600V (UL)	8A-20A	18-12	
FICXI Tube (13)		•		P	2-5		•			450V (Non-UL) 600V (UL)	8A-20A	18-12	
FICXT Tube (T2)		•		P	2-5		•			450V (Non-UL) 600V (UL)	10A-20A	20-12	
Cable Gland Series													
Cable Gland		•		B									
Pressure Relief Vent													
M6 Plastic		•		P				•					1,000h
M12 Snap-in		•		P				•					1,000h
M12 Stainless		•		M					•				1,000h
M12 Plastic		•		P				•					1,000h
M12 Metal		•		M			•						48h
LED Light Guide													
Ø3mm				B				•		4V			
Ø5mm				M				•		4V			

Remarks:
Materials: P (Plastic), M (Metal), B (Both)
Assemble Style: RO (Receptacle)

Product Selection Guide

	FI	UV Resistant	UL 94V-0	EMI Option	ROHS 2.0 & REACH	Standard / Compliant / Certifications	Operating Temperature & IP Rating
Fiber Optic Series							
LC	•	•	•		•		-40°C - 105°C, IP67 (Mated)
SC	•	•	•		•		-40°C - 105°C, IP67 (Mated)
RF Series							
SMA Type				•	•	MIL-C-39012	-40°C - 105°C, IP68 (Unmated)
N Type				•	•	MIL-C-39012	-40°C - 105°C, IP68 (Unmated)

	Receptacle	Field Installable	UV Resistant	UL 94V-0	Vibration	ROHS 2.0 & REACH	Certifications	IP Rating	Operating Temperature
ZConnect Series									
FPC / FFC / WTB				•		•			-40°C - 110°C, Non-IP
Cable Joiner Series									
M20		•	•	94V-2		•		IP67	-40°C - 105°C
M32		•	•	•		•	UL6703A	IP67	-40°C - 105°C
FICX I Tube (11)		•	•	•		•	CSA, UL2238	IP68 (Mated)	-40°C - 105°C
FICX I Tube (12)		•	•	•		•	CSA, UL2238	IP68 (Mated)	-40°C - 105°C
FICX XI Tube (13)		•	•	•		•	CSA, UL2238	IP68 (Mated)	-40°C - 105°C
FICX T Tube (T2)		•	•	•		•	CSA, UL2238	IP68 (Mated)	-40°C - 105°C
Cable Gland Series									
Cable Gland	•	•		94V-0 94V-2	(2)	•		IP67 (Mated) IP68 (Mated)	• RO : -20°C - 105°C • FI : -20°C - 105°C
Pressure Relief Vent									
M6 Plastic	•		•	•		•		IP66, IP68	-40°C - 125°C
M12 Snap-in	•		•	•		•		IP68, IP69K	-40°C - 125°C
M12 Stainless	•		•	•		•		IP68, IP69K	-40°C - 125°C
M12 Plastic	•		•	•		•		IP68, IP69K	-40°C - 125°C
M12 Metal	•		•	•		•		IP68, IP69K	-40°C - 125°C
LED Light Guide									
Ø3mm	•							IP67	• Red & Green : -30°C - 80°C • Others : -40°C - 80°C
Ø5mm	•							IP67	• Red & Green : -30°C - 80°C • Others : -40°C - 80°C

Remarks:

Assemble Style: FI (Field Installable)

Vibration: (2) 10-55Hz @Amplitude 1.52mm

Operation Temperature & IP Rating: RO (Receptacle), FI (Field Installable)

Served Markets & Applications

Applications	Ceres	X-Lok	M series	FLOS & FLOS+	Power	RBL	HS-Lok	NMEA 2000	7/8" Mini	Heavy Duty Shielded	RJ45	USB	SSL	HDMI	DVI	Fiber Optics	Zconnect	RF	Cable Joiner	Cable Gland	Vent	LED Light Guide	D-Sub
LED Lighting																							
Architectural Lighting	•	•	•		•	•	•		•		•	•					•		•	•	•		
Outdoor LED Displays	•	•	•	•	•	•			•		•	•					•		•	•	•		
Outdoor Signage	•	•			•	•			•		•	•					•		•	•	•		
Entertainment Lighting & Systems	•	•			•	•	•		•		•	•					•		•	•	•		
Smart City, Street Lighting	•	•			•	•			•		•	•					•		•	•	•		
Tunnel Lighting	•	•	•		•	•			•		•	•					•		•	•	•		
Parking Lighting	•	•			•	•	•		•		•	•					•		•	•	•		
Cruise & Shipyards Lighting	•	•	•		•	•		•	•		•	•					•		•	•	•		
High Speed Train & EV Bus	•	•			•	•	•		•	•	•	•					•		•	•	•		
Commercial Lighting	•	•			•	•	•		•		•	•					•		•	•	•		
Refrigeration Lighting	•	•			•	•	•		•		•	•					•		•	•	•		
Horticulture Lighting	•	•	•		•	•			•		•	•					•		•	•	•		
Warehouse Lighting	•	•			•	•			•		•	•					•		•	•	•		
Emergency Lighting	•	•	•		•	•	•		•		•	•					•		•	•	•		
UV and Sanitary Lighting	•	•	•		•	•	•		•		•	•					•		•	•	•		
Li-Fi	•	•			•	•	•		•		•	•					•	•	•	•	•		
Hospital Surgical Lighting & Room	•	•	•		•	•	•		•		•	•					•	•	•	•	•		
ATEX Lighting	•	•			•	•	•		•		•	•					•		•	•	•		
Underwater / Submerged Lighting	•	•			•	•			•		•	•					•		•	•	•		
Marine																							
Multi-FunctionDisplay	•	•	•	•	•	•		•	•	•	•	•		•	•		•	•			•	•	•
Outboard Motors	•	•	•		•	•		•	•	•							•			•			
Bilge Pump	•	•	•		•	•		•	•	•							•			•			
Heater	•	•	•		•	•	•		•	•	•						•		•	•	•		
HVAC (Heating Ventilation Air Conditioning)	•	•	•		•	•	•		•	•	•						•		•	•	•		
Fridge	•	•	•		•	•	•		•	•	•						•						
Docking System	•	•	•		•	•			•	•	•						•			•			
Windlass	•	•	•		•	•			•	•	•						•			•			
Sensors	•	•	•		•	•			•	•	•						•						
RADAR	•	•	•		•	•			•	•	•	•					•	•					
Antenna	•	•	•		•	•			•	•	•						•	•					
USB Charger	•	•	•		•	•			•	•	•	•					•		•				
Audio System	•	•	•		•	•			•	•	•			•			•		•	•	•		
Lighting System	•	•	•		•	•			•	•	•	•	•				•		•	•	•		•
CCTV	•	•	•		•	•			•	•	•	•			•		•						
Power Controller	•	•	•		•	•			•	•	•						•		•	•	•		•
Autopilot System	•	•	•		•	•			•	•	•			•	•		•	•			•		•
Automatic Identification System	•	•	•		•	•			•	•	•			•	•		•	•			•		•
GPS, Beacon & Lifebuoy	•	•	•		•	•			•	•	•	•					•	•			•		•
Sonar / Transducer	•	•	•		•	•			•	•	•						•						
Fish-Finders	•	•	•		•	•			•	•	•						•						
Chartplotter	•	•	•		•	•			•	•	•			•			•						•
Sailing Instruments	•	•	•		•	•			•	•	•			•	•		•				•		•
Shipyards & Cruise	•	•	•		•	•			•	•	•			•	•		•				•		•
Broadband Wireless Access																							
General Small Cells	•	•	•		•	•			•	•	•	•				•	•	•	•	•	•	•	•
RRH (Remote Radio Head)	•	•	•		•	•			•	•	•	•				•	•	•	•	•	•	•	•
Wireless Mobile Backhaul	•	•	•		•	•			•	•	•	•				•	•	•	•	•	•	•	•
High Capacity Mobile Subscriber Unit	•	•	•		•	•			•	•	•	•				•	•	•	•	•	•	•	•
Outdoor Base Station Unit	•	•	•		•	•			•	•	•	•				•	•	•	•	•	•	•	•
Outdoor LTE	•	•	•		•	•			•	•	•	•				•	•	•	•	•	•	•	•
Outdoor AP	•	•	•		•	•			•	•	•	•				•	•	•	•	•	•	•	•
Subscriber Station	•	•	•		•	•			•	•	•	•				•	•	•	•	•	•	•	•
Outdoor Wireless Mesh Router	•	•	•		•	•			•	•	•	•				•	•	•	•	•	•	•	•
Base Station Power Supply	•	•	•	•	•	•			•	•						•	•	•	•	•	•	•	•
Communication System																	•						

Served Markets & Applications

Applications	Ceres	X-Lok	M series	FLOS & FLOS+	Power	RBL	HS-Lok	7/8" Mini	Heavy Duty Shielded	RJ45	USB	SSL	HDMI	DVI	Fiber Optics	Zconnect	RF	Cable Joiner	Cable Gland	Vent	LED Light Guide	D-Sub
Industrial Automation																						
Robotic Arm			•	•			•	•	•							•						
Industrial Server / Network	•	•	•	•	•		•	•	•	•	•		•	•	•					•	•	•
Industrial Forklifts (Truck)	•	•	•	•	•	•	•	•	•	•	•		•	•					•	•		•
AVI (Automatic visual inspection)	•	•	•	•	•		•	•	•							•						
Data Communication System	•	•	•	•	•		•	•	•	•	•		•	•			•				•	•
Industrial Control Center	•	•	•	•	•		•	•	•	•	•		•	•							•	•
Packaging Center	•	•	•	•	•		•	•	•							•						
Conveyors	•	•	•	•	•		•	•	•							•						
Sensors			•				•	•	•							•						
Power Distribution	•	•	•	•	•		•	•	•							•						
Actuators	•	•	•				•	•	•							•						
Motor Drives	•	•	•		•	•	•	•	•							•						
Industrial PC & Displays	•	•	•	•	•		•	•	•	•	•		•	•			•				•	•
Machine Tools	•	•	•	•	•		•	•	•							•						
Switches		•	•				•	•	•	•	•					•						•
Production Equipment	•	•	•	•	•	•	•	•	•	•	•					•					•	•
Renewable Energy																						
PV / DC Inverter	•	•	•		•	•		•	•	•						•		•	•	•	•	
Micro Inverter						•										•			•	•	•	
CSP & CPV	•	•	•		•	•		•	•							•			•	•	•	
Heliostat	•	•	•		•	•		•	•							•			•	•	•	
PV Trackers	•	•	•		•	•		•	•							•			•	•	•	
PV ICS (Integrated Control Systems)					•	•		•	•	•						•					•	
Portable Energy	•	•	•		•	•	•	•	•	•	•					•						•
Communication System	•	•	•	•	•	•		•	•	•	•		•	•	•	•	•		•	•	•	•
PDC (Power Distribution Control)	•	•	•	•	•	•		•	•	•	•					•	•				•	•
Wind Turbine	•	•	•	•	•	•		•	•	•	•					•			•	•	•	•
Energy Storage System	•	•	•		•	•		•	•	•	•					•			•	•	•	
Tidal Power Generation System	•	•	•	•	•	•		•	•	•	•					•			•	•	•	•
Heavy Equipment																						
Electronic Toll System	•	•	•	•	•	•	•	•	•	•	•		•	•		•	•		•	•	•	•
Automotive Diagnostics	•	•	•	•	•	•	•	•	•	•	•	•	•	•		•	•		•	•	•	•
Agriculture Electronic Equipment	•	•	•	•	•	•	•	•	•	•	•		•	•		•	•		•	•	•	•
Lidar & Radar	•	•	•	•	•		•	•	•	•	•		•	•		•						•
ADAS (Advanced Driver Assistance Systems)	•	•	•	•	•	•	•	•	•	•	•		•	•		•	•		•	•	•	•
Telematics & Tracking	•	•	•		•	•	•	•	•	•	•		•	•		•	•	•	•	•	•	•
Camera & Monitoring	•	•	•	•	•	•	•	•	•	•	•		•	•		•	•		•	•	•	•
Control System	•	•	•	•	•	•	•	•	•	•	•		•	•		•	•		•	•	•	•
Display	•	•	•	•	•	•	•	•	•	•	•		•	•		•	•		•	•	•	•
GPS System	•	•	•	•	•	•	•	•	•	•	•		•	•		•	•		•	•	•	•
Lighting	•	•	•	•	•	•	•	•	•	•	•	•				•	•	•	•	•	•	•
Measurement Systems	•	•	•	•	•	•	•	•	•	•	•		•	•		•	•		•	•	•	•
Sensors		•	•	•	•	•	•	•	•	•	•					•						
Automated Meter Reading																						
Water Meter	•	•	•	•	•		•			•	•					•	•		•	•	•	•
Electricity Meter	•	•	•	•	•		•			•	•					•	•		•	•	•	•
Gas Meter	•	•	•	•	•		•			•	•					•	•		•	•	•	•
Alarm System	•	•	•	•	•		•			•	•					•	•		•	•	•	•
Military Drone	•	•	•	•	•		•									•	•		•	•	•	•
Vehicle Tracking	•	•	•	•	•		•			•	•					•	•		•	•	•	•
Telemetry	•	•	•	•	•		•			•	•					•	•		•	•	•	•
Sewage	•	•	•	•	•	•	•	•	•	•	•					•	•		•	•	•	•
Rugged IT																						
Telemetry		•	•	•	•		•			•						•	•		•	•		
Rugged & Military VR and AR		•	•	•	•		•			•						•	•		•	•		
Rugged Notebook				•	•					•	•		•	•		•	•					•
Night Vision Goggles			•	•	•		•			•						•	•					
Miniature Camera										•						•	•					
Rugged Tablet										•	•		•	•		•	•					
Communication Devices				•	•					•	•		•	•		•	•				•	•

Served Markets & Applications

Applications	Ceres	X-Lok	M series	FLOS & FLOS+	Power	RBL	HS-Lok	7/8" Mini	Heavy Duty Shielded	RJ45	USB	SSL	HDMI	DVI	Zconnect	RF	Cable Gland	Vent	LED Light Guide	D-Sub
Test Equipments																				
Air Flow Measurement	•	•	•	•	•	•	•	•	•	•	•				•	•		•		
Gas Detectors	•	•	•	•	•	•	•	•	•	•	•				•	•		•		
Precision Surveying	•	•	•	•	•	•	•	•	•	•	•		•	•	•	•		•		•
Earthquake Monitoring	•	•	•	•	•	•	•	•	•	•	•				•	•		•		
Humidity Measurement	•	•	•	•	•	•	•	•	•	•	•				•	•		•		
Leak Detectors	•	•	•	•	•	•	•	•	•	•	•				•	•		•		
Light Measuring	•	•	•	•	•	•	•	•	•	•	•				•	•		•		
Sound Measuring	•	•	•	•	•	•	•	•	•	•	•				•	•		•		
Water Measurement	•	•	•	•	•	•	•	•	•	•	•				•	•		•		
Weighing Devices	•	•	•	•	•	•	•	•	•	•	•				•	•	•	•		
Weigh Modules	•	•	•	•	•	•	•	•	•	•	•				•	•	•	•		
Heavy-duty Scales	•	•	•	•	•	•	•	•	•	•	•		•	•	•	•	•	•		•
Floor Scales	•	•	•	•	•	•	•	•	•	•	•		•	•	•	•	•	•		•
Wet Area Weighing	•	•	•	•	•	•	•	•	•	•	•				•	•	•	•		
Dosing Systems	•	•	•	•	•	•	•	•	•	•	•				•	•	•	•		
In-Motion Weighing	•	•	•	•	•	•	•	•	•	•	•				•	•	•	•		
Borescope	•	•	•	•	•	•	•	•	•	•	•				•	•	•	•		
Image Measurement	•	•	•	•	•	•	•	•	•	•	•				•	•	•	•		
Timers / Timer Display	•	•	•	•	•	•	•	•	•	•	•				•	•	•	•		
Laser Marking System	•	•	•	•	•	•	•	•	•	•	•				•	•	•	•		
Digital Microscopes	•	•	•	•	•	•	•	•	•	•	•				•	•	•	•		
Hybrid Electric Vehicles																				
Electric Wheelchair	•	•	•	•	•	•	•	•	•						•					
Electrical and Electronic Speed Control	•	•	•	•	•	•	•	•	•						•					
Electrical and Electronic Brake System	•	•	•	•	•	•	•	•	•						•					
Throttle Controller	•	•	•	•	•	•	•	•	•						•					
Battery Module	•	•	•	•	•	•	•	•	•						•		•	•		
Motor Module	•	•	•	•	•	•	•	•	•	•	•				•		•	•		
Gear Shift Module	•	•	•	•	•	•	•	•	•	•	•				•					
Controller Unit	•	•	•	•	•	•	•	•	•	•	•				•					
Charge Plug / Inlet	•	•	•	•	•	•	•	•	•	•	•				•					
Charging Station	•	•	•	•	•	•	•	•	•	•	•				•					
Home Charge Platform	•	•	•	•	•	•	•	•	•	•	•				•					
Hoverboard	•	•	•	•	•	•	•	•	•	•	•				•					
Electric Scooter	•	•	•	•	•	•	•	•	•	•	•				•		•			
Railway Mass Transit																				
Infotainment Systems	•	•	•	•	•	•	•	•	•	•	•		•	•	•		•	•	•	•
In-Vehicle Information System	•	•	•	•	•	•	•	•	•	•	•		•	•	•		•	•	•	•
Indication Display	•	•	•	•	•	•	•	•	•	•	•		•	•	•		•	•	•	•
Navigation/GPS	•	•	•	•	•	•	•	•	•	•	•		•	•	•	•		•	•	•
HVAC (Heating Ventilation Air Conditioning)	•	•	•	•	•	•	•	•	•	•	•				•					
Fuel Leakage Detector	•	•	•	•	•	•	•	•	•	•	•				•					
Broadcasting System	•	•	•	•	•	•	•	•	•	•	•				•		•			
Vehicle Monitoring	•	•	•	•	•	•	•	•	•	•	•		•	•	•		•			•
Cleaning Control	•	•	•	•	•	•	•	•	•	•	•				•					
Speedometer	•	•	•	•	•	•	•	•	•	•	•				•					
Interior Lighting	•	•	•	•	•	•	•	•	•	•	•				•					
Mobile Devices																				
DRC (Drone Remote Controller)	•	•	•	•	•	•	•	•	•	•	•				•	•				
Altimeter	•	•	•	•	•	•	•	•	•	•	•				•	•				
Barcode Reader	•	•	•	•	•	•	•	•	•	•	•				•					
GPS Safety Guard	•	•	•	•	•	•	•	•	•	•	•				•	•				
Portable Lamp	•	•	•	•	•	•	•	•	•	•	•				•					
Gesture Measurement	•	•	•	•	•	•	•	•	•	•	•				•					
Wearables	•	•	•	•	•	•	•	•	•	•	•				•	•				

Served Markets & Applications

Applications	Ceres	X-Lok	M series	FLOS & FLOS+	Power	RBL	HS-Lok	7/8" Mini	Heavy Duty Shielded	RJ45	USB	SSL	HDMI	DVI	Zconnect	RF	Cable Joiner	Cable Gland	Vent	LED Light Guide	D-Sub
Transportation																					
Vehicle Camera	•	•	•	•		•	•				•		•		•			•	•		
Switch			•							•	•				•						•
Dome Vehicle Camera	•	•	•			•									•						
RFID Reader															•	•					
Bus GPS	•	•	•	•		•	•			•	•		•	•	•	•					
Displayer	•	•	•	•		•	•								•						
Outdoor Speaker	•	•	•	•		•									•						
Automotive Winches															•						
Vehicle Charger	•	•	•			•									•						
Wifi Router										•					•						
Fleet Management	•	•	•	•		•	•								•						
Digital Video Surveillance System	•	•	•	•		•	•	•	•	•					•						•
Medical Equipment																					
Medical Displays				•	•					•	•		•	•	•					•	•
Mobile Nursing Carts	•	•			•	•	•	•	•						•				•	•	
Non-invasive Devices	•	•		•	•	•	•	•	•	•	•		•	•	•				•	•	•
Electrical Beds	•	•	•		•	•		•	•						•				•	•	
Charges	•	•			•	•		•	•						•				•	•	
Wheelchair Lift	•	•			•	•		•	•						•				•	•	
Wheelchair Stair Lift	•	•			•	•		•	•						•				•	•	
Rehabilitation System	•	•			•	•		•	•						•				•	•	
Automotive Diagnostics																					
Auto Crash Notification	•	•	•	•	•	•	•	•	•	•	•				•	•					•
Vehicle Tracking	•	•	•		•	•	•	•	•		•				•	•				•	
Vehicle Health Alert & Roadside Assistance	•	•	•	•	•	•	•	•	•	•	•				•	•					•
Remote Vehicle Diagnostics	•	•	•	•	•	•	•	•	•	•	•	•	•	•	•	•				•	•
UAV																					
Commercial Drone	•	•	•	•	•	•	•	•	•	•	•		•	•	•	•			•	•	•
Military Drone	•	•	•	•	•	•	•	•	•	•	•		•	•	•	•			•	•	•
Consumer Drone	•	•	•	•	•	•	•	•	•	•	•		•	•	•	•			•	•	•
Lifts & Materials Handling																					
Forklift	•	•	•	•	•	•	•	•	•	•	•		•	•	•				•	•	•
Industrial Lift	•	•	•	•	•	•	•	•	•	•	•		•	•	•				•	•	•
Materials Handling	•	•	•	•	•	•	•	•	•	•	•		•	•	•				•	•	•
Remote Video Response Center																					
Encoders	•	•	•	•	•	•	•	•	•	•	•		•	•	•	•			•	•	•
Monitoring Station	•	•	•		•	•		•	•	•	•		•	•	•				•	•	•
CCTV/Dome/IP Camera	•	•	•	•	•	•		•	•	•	•		•	•	•	•			•	•	•
Remote Control	•	•			•	•		•	•	•	•		•	•	•				•	•	•
Junction Box	•	•			•					•	•		•	•	•				•	•	•
Automatic LPRS (License Plate Recognition System)	•	•	•	•	•		•	•	•	•	•		•	•	•	•			•	•	•
Fingerprint ID											•				•						
Alarm System	•	•	•	•	•					•	•		•	•	•	•			•	•	•
Sensor			•												•						
Autonomous																					
GPS	•	•	•	•			•	•	•	•	•		•	•	•	•					
Lidar	•	•	•	•			•	•	•	•	•		•	•	•				•	•	
Radar Sensors	•	•	•	•			•	•	•	•	•		•	•	•				•	•	
Video Cameras	•	•	•	•			•	•	•	•	•		•	•	•				•	•	
Central Computer	•	•	•	•			•	•	•	•	•		•	•	•						
Inertial Measurement Unit	•	•	•	•			•	•	•						•						
Inertial Navigation Systems	•	•	•	•			•	•	•						•	•					
Commercial Military																					
Tank				•																	
Aircraft				•																	
Warship				•																	
Dismounted Soldier				•																	
Software Defined Radios				•																	
Commercial Military				•											•						

We Are Amphenol LTW

Founded in 1993, Amphenol LTW is a leader in rugged and harsh environment interconnects with the largest array of I/O and products ranging from IP65 to IP69K. The company continually provides innovative interconnect solutions for ever-demanding environments and is proactively committed to contributing to a safer and greener environment. Amphenol LTW features interconnects for technologically advanced products with environmentally friendly results.



Amphenol LTW Technology & CNC Plant

- Headquarters: Taipei, Taiwan
- 150 Employees

Kunshan Amphenol Zhengri Electronics

- Kunshan, China
- 400 Employees



110+
Amphenol
Divisions



75+
Distribution
Channels



30+
Market
Applications

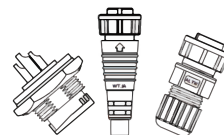

80,000+
Products

Visit our website for
more information

Scan here



Our Capabilities

Both factories located in Taiwan and China are ISO9001:2015, ISO14001:2015, and UL certified. Our Test Laboratory is certified by TAF and is a member of UL WTDP reliable partner. Wherever required, most of our products are TUV/VDE, UL/CSA certified. Thanks to our strict standards, we are able to contribute to your projects and design exactly what you need. From standard to customized products, Amphenol LTW has the right solutions for your applications.



Test Laboratory Accreditations Quality Assurance

International Certifications



Automated Production Line

Capability: Contacts, Parts, and Shells

Number of Automatic Machines: 11

Production Capacity : 125,000 pins per day
(24 hours)

Number of CNC Machines: 33

Production Capacity : 125,000 pins per day
(24 hours)



Kunshan Factory – Horizontal Injection Workshop

Molding Machines

Number of Machines: 17

Production Capacity : 3,400pcs/hr

Online Resources

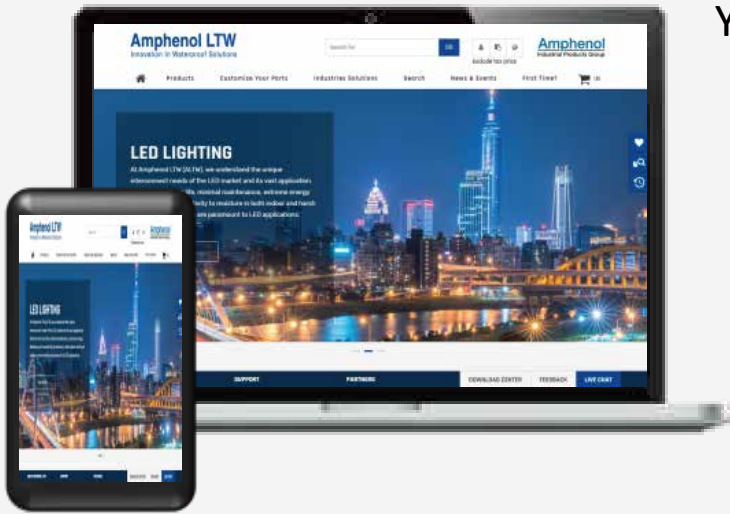

amphenolltw.com

Your Solution Only **One Click Away**

Our E-SHOP

Visit our website to find all our products, prices and technical data. Online ordering is easier now!



Scan our QR Code

Visit the online shop



Our Catalog

Product catalogs are available on our website.

Download for more details:
amphenolltw.com



Scan for more details



General Catalog

Find All Product Range



Catalogs by Series

All Market Applications



Market Flyer

Product Guidance

Customization Services

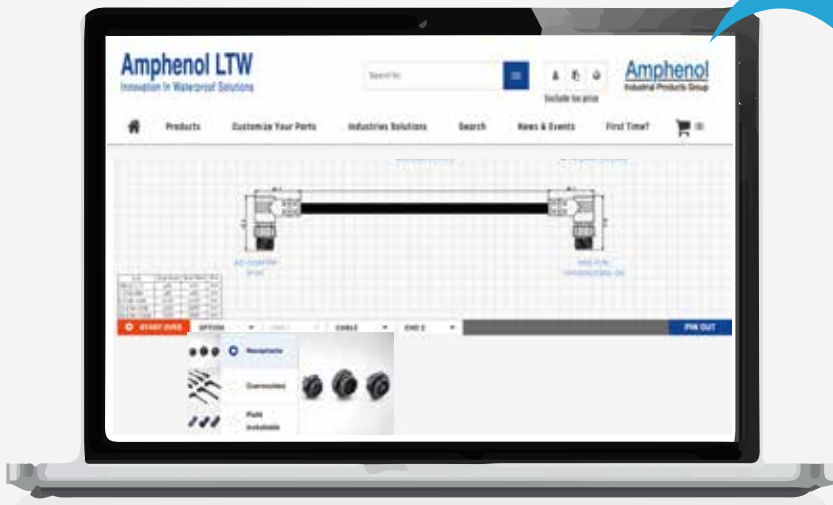

amphenolltw.com

Fast
Efficient

Configure To Order (CTO)

Configure your own connector/cable assembly directly on our website by choosing the components and parts that you need.

Benefits

- ✓ Worldwide access 24/7
- ✓ Easy & quick customization
- ✓ Real time order tracking
- ✓ Online assistance (Live Chat)
- ✓ Instant drawing release
- ✓ Instant quote
- ✓ Order online

Scan the QR Code
to our CTO platform

Scan here



Just A Few Simple Steps



NEW

3³ Single Pair Ethernet

Freedom of Choices and Budgets

- 3 Mechanical interfaces IP67 and above for industrial and ruggedized applications
- 3 Freedom of choices for your needs and requirements
- 3 Budgets, pay for what you need



Features

- » ALTW's proprietary SPE interface integrated in **M8 (G8) / M12 / FLOS+ / X-Lok**
- » Providing low power & simply networking on end-point sensors
- » Cost-effective, smaller & lighter than standard 4 pairs ethernet cable
- » Compatible 10/100/1000 base-T1 data rates as existing technologies **
- » Receptacle IP67 **UNMATED** waterproof, also available in double ended and field installable
- » Vibration resistance 20g (10 ~ 2,000 Hz)
- » Supports PoDL (Power Over Data Lines)

** 24~26 AWG Standard Length 15m

Part Number

X-Lok

A Size	AD-02BFFM-QL8P ¹⁰ (Cable)
	AD-02BMMM-QL8P ¹⁰ (Cable)
	AD-02PMMP-QC8001 (Receptacle)
	AD-02PMMS-QC8001 (Receptacle)

FLOS+

K Series	SLKC-S02FMMM-GCP-C ¹⁰ (Cable)
	SLKC-S02EEFP-GCP-001 (Receptacle)

M Series

M8	M8-02BFFM-SL7C ¹⁰ * (Cable)	M12	M12A-02BFFM-SL8C ¹⁰ (Cable)
	M8-02BMMM-SL7C ¹⁰ * (Cable)		M12A-02BMMM-SL8C ¹⁰ (Cable)
	M8-02PFFP-SF7001* (Receptacle)		M12A-02PFFP-SF8001(Receptacle)
	M8-02PMMP-SF7001* (Receptacle)		M12A-02PMMP-SF8001(Receptacle)
	M8-02PFFS-SF7001* (Receptacle)		
	M8-02PMMS-SF7001* (Receptacle)		
G8	8A-02BFFM-SL7C ¹⁰ * (Cable)		
	8A-02BMMM-SL7C ¹⁰ * (Cable)		
	8A-02PFFP-SF7001* (Receptacle)		
	8A-02PFFS-SF7001* (Receptacle)		
	8A-02MMP-SF7001 (Receptacle)		
	8A-02PMMS-SF7001 (Receptacle)		



* Upon Request

¹⁰ Cable Length: (01) 1M ~ (15) 15M.

Technical Support



Assistance



AIPG WeChat (ID: AIPG2020)
安费诺工业展品集团
微信公众号: AIPG2020



88677416888

Information



FAQ

Find answers to frequently asked questions at
<https://www.amphenolltw.com/>



Feedback

Any comments about the catalog?
Help us improve the catalog user experience by sharing your suggestions.
Email us at
sales@ltw-tech.com

Follow us on





Marine

- AIS
- Antenna
- Audio System
- Chartplotter
- Heater
- Lighting System
- RADAR
- Shipyards & Cruise
- USB Charger
- Fridge & Refrigeration
- GPS, Beacon & Lifebuoy
- IP and Infrared CCTV & Cameras
- HVAC (Heating Ventilation Air Conditioning)



LED

- Architectural Lighting
- ATEX Lighting
- Commercial Lighting
- Cruise & Shipyards Lighting
- Emergency Lighting
- Parking Lighting
- Refrigeration Lighting
- UV and Sanitary Lighting
- Entertainment Lighting & Systems
- Hospital Surgical Lighting & Room
- Train, Bus, Plane & Recreational Vehicles Lighting



Industrial Automation

- Industrial Control
- Industrial Forklifts
- Industrial Network
- Industrial PC & Displays
- Industrial Robots
- Packaging
- Conveyors
- AVI (Automatic Visual Inspection)
- Communication System
- Production Equipment



Broadband Wireless Access

- Outdoor AP
- Outdoor Base Station Unit
- Outdoor LTE
- Outdoor Repeater
- Outdoor Wireless Mesh Router
- RRH (Remote Radio Head)
- Subscriber Station
- Wireless Mobile Backhaul
- General Small Cells
- Base Station Power Supply
- High Capacity Mobile Subscriber Unit



Heavy Equipment

- Display
- Electronic Toll System
- Measurement Systems
- Sensors
- Telematics & Tracking
- Control System
- Camera & Monitoring
- Automotive Diagnostics
- Agriculture Electronic Equipment
- ADAS (Advanced Driver Assistance Systems)
- GPS System



Railway Mass Transit

- Interior Lighting
- In-Vehicle Information
- Navigation / GPS
- Speedometer
- Vehicle Monitoring
- Broadcasting System
- Cleaning Control
- Fuel Leakage Detector
- Infotainment Systems
- HVAC (Heating Ventilation Air Conditioning)
- Indication Display



Test Equipment

- Timers / Timer Display
- Water Measurement
- Weigh Modules
- Weighing Devices
- Wet Area Weighing
- Floor Scales
- Dosing Systems
- Laser Marking System
- Leak Detectors
- Light Measuring
- Precision Surveying
- Sound Measuring
- Borescope
- Gas Detectors
- Digital Microscopes
- Heavy-Duty Scales
- Humidity Measurement
- Image Measurement
- In-Motion Weighing
- Air Flow Measurement
- Earthquake Monitoring



Hybrid Electric Vehicles

- Electric Scooter
- Electric Wheelchair
- Electrical and Electronic Brake System
- Electrical and Electronic Speed Control
- Throttle Controller



Mobile Devices

- Altimeter
- Barcode Reader
- DRC (Drone Remote Controller)
- Gesture Measurement
- GPS Safety Guard
- Portable Lamp



Remote Video Response Center

- Alarm System
- Automatic LPRS (License Plate Recognition System)
- CCTV / Dome / IP Camera
- Encoders
- Remote Control



Automated Meter Reading

- Electricity Meter
- Gas Meter
- Sewage
- Telemetry
- Water Meter
- Alarm System
- Military Drone
- Vehicle Tracking



Automotive Diagnostics

- Auto Crash Notification
- Remote Vehicle Diagnostics
- Vehicle Health Alert & Roadside Assistance
- Vehicle Tracking



Autonomous

- Central Computer
- GPS
- Inertial Measurement Unit
- Inertial Navigation Systems
- Lidar
- Radar Sensors
- Video Cameras



Lifts & Materials Handling

- Forklift
- Industrial Lift
- Materials Handling



Renewable Energy

- Portable Energy



Medical

- Mobile Nursing Carts
- Non-invasive Devices



Rugged IT

- Night Vision Goggles
- Rugged & Military VR and AR
- Telemetry



UAV

- Commercial Drone
- Consumer Drone
- Military Drone



Transportation

- Vehicle Camera
- Bus GPS

HS-Lok

- IP68 Mated Or Unmated
- Metal / Plastic Version
- Push Pull Quick Mating Mechanism
- Blind Mating With Audible Feedback
- Power, Data / Signal, Hybrid
- Flammability UL 94V-0 & UV Resistant
- UL Certified



Product Range Overview

Sub-Series Name	Q8
Mating Style	Push Pull
Plastic Version	✓
Metal Version	✓
No. of Contacts	2 ~ 6
Housing Material	UL Recognized Thermoplastic
Plating of Contacts	Gold Plated
Rated Voltage (AC/DC)	100V (DC): 2A 300V: 5A 300V (AC) + 100V (DC): 5A+2A
Nominal Current	2A, 5A, 5A+2A
Operating Temperature	<ul style="list-style-type: none"> • Receptacle: -40°C ~ 105°C • Overmolded with Cable: -40°C ~ 105°C • Field Serviceable/Installable: -40°C ~ 105°C
Fasten Style of Nut	Front
Accessories	✓
Applicable Wire Gauge	<ul style="list-style-type: none"> • Overmolded With Cable: <ul style="list-style-type: none"> (2A) UL21996, 24AWG (0.25mm²), PVC, Black (5A) UL21996, 20AWG (0.50mm²), PVC, Black (5A+2A) UL21996, 20AWG (0.50mm²), 24AWG (0.25mm²), PVC, Black • Field Serviceable/Installable: 24 ~ 20AWG (0.25²) ~ 0.50mm
Mating Cycles (Pin Contact)	2,000 Cycles
IP Rating	<ul style="list-style-type: none"> • Receptacle: IP68 (Unmated, 1M / 24h) • Overmolded With Cable, Field Serviceable/Installable: IP68 (Mated, 1M / 24h)
Salt Spray (Connector, Mated)	500h
UV Resistant	f1
Flammability Rating	UL94V-0
Vibration	Frequency Range 10 ~ 55Hz / Amplitude 1.52mm
RoHS 2.0 Compliant	✓
REACH Compliant	✓
Certificates	UL2238, UL50e

Assemble Style



Solder
(S) Receptacle
(A) Field Serviceable/Installable

No of Contacts	2		3		4	
Rated Voltage (AC/DC)	300V		300V		300V	
Nominal Current	5A		5A		5A	
Plastic / Metal	Plastic	Metal	Plastic	Metal	Plastic	Metal
Pin Assignment	MM/FF		MM/FF		MM/FF	
MM : Male Connector Male Contact FF : Female Connector Female Contact						
Receptacle, Hexagonal Flange, FRONT Fastened Nut, IP68 (Unmated) Nut Torque Value: 4 ~ 6 kgf-cm Recommend Panel Thickness: Min. 0.8mm ~ Max. 2.0mm						
	Q8D-02P MM S- QF8001	Q8SD-02P MM S- QF8001 *	Q8D-03P MM S- QF8001	Q8SD-03P MM S- QF8001 *	Q8D-04P MM S- QF8001	Q8SD-04P MM S- QF8001 *
STRAIGHT , Overmolded Cable Assembly, Free Cable End, With Strain Relief, IP68 (Mated) ⑩ Cable Length: (01) 1M ~ (99) 99M ¹⁾						
	Q8D-02A MM M- QL8A ⑩	-	Q8D-03A MM M- QL8A ⑩	-	Q8D-04A MM M- QL8A ⑩	-
STRAIGHT-TO-STRAIGHT , Overmolded Double-Ended Cable Assembly, IP68 (Mated) ⑩ Cable Length: (A05) 0.5M, (01) 1M ~ (99) 99M ¹⁾ Connector / Contact Gender: (M) MM, (F) FF						
	Q8D02 ML - Q8D ML -QLA ⑩ *	-	Q8D03 ML - Q8D ML -QLA ⑩ *	-	Q8D04 ML - Q8D ML -QLA ⑩ *	-
	Q8D02 ML - Q8D FL -QLA ⑩ *	-	Q8D03 ML - Q8D FL -QLA ⑩ *	-	Q8D04 ML - Q8D FL -QLA ⑩ *	-
STRAIGHT , Overmolded Cable Assembly, Free Cable End, With Strain Relief, IP68 (Mated) ⑩ Cable Length: (01) 1M ~ (99) 99M ¹⁾						
	Q8D-02A FF M- QL8A ⑩	-	Q8D-03A FF M- QL8A ⑩	-	Q8D-04A FF M- QL8A ⑩	-
Field Serviceable/Installable, STRAIGHT , Solder Type, IP68 (Mated) Sealing Nut Torque Value: 5 ~ 8 kgf-cm Cable O.D.: 5.2 ~ 6.0mm						
NEW	Q8D-02B FF A- QL8001 *	-	Q8D-03B FF A- QL8001 *	-	Q8D-04B FF A- QL8001 *	-



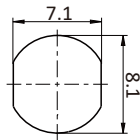

Accessories

Waterproof Cap	Mating Pair (Gender)	Part Number
	Female	CAP-WBBFQCA1
	Male	CAP-WBBMQMA1
	Male	CAP-WBBMQMD1

Panel Cut Out



(Unit: mm)

4 (2+2)		5		5 (2+3)		6	
300V (AC) + 100V (DC)		100V (DC)		300V (AC) + 100V (DC)		100V (DC)	
5A+2A		2A		5A+2A		2A	
Plastic	Metal	Plastic	Metal	Plastic	Metal	Plastic	Metal
MM/FF		MM/FF		MM		MM/FF	
							
Q8DU-04P MMS - QF8001 *	Q8SDU-04P MMS - QF8001 *	Q8U-05P MMS - QF8001	Q8SU-05P MMS - QF8001 *	Q8DU-05P MMS - QF8001	Q8SDU-05P MMS - QF8001 *	Q8U-06P MMS - QF8001	Q8SU-06P MMS - QF8001 *
Q8DU-04A MMM - QL8A 10 *	Q8SDU-04A MMM - QL8A 10 *	Q8U-05A MMM - QL8A 10	-	Q8DU-05A MMM - QL8A 10	-	Q8U-06A MMM - QL8A 10	-
Q8DU04 ML - Q8DU ML -QLA 10 *	Q8SDU04 ML - Q8SDU ML -QLA 10 *	Q8U05 ML - Q8U ML -QLA 10 *	-	Q8DU05 ML - Q8DU ML -QLA 10 *	-	Q8U06 ML - Q8U ML -QLA 10 *	-
Q8DU04 ML - Q8DU FL -QLA 10 *	Q8SDU-04 ML - Q8DU FL -QLA 10 *	Q8U05 ML - Q8U FL -QLA 10 *	-	Q8DU05 ML - Q8DU FL -QLA 10 *	-	Q8U06 ML - Q8U FL -QLA 10 *	-
Q8DU-04A FFM - QL8A 10 *	Q8SDU-04A FFM - QL8A 10 *	Q8U-05A FFM - QL8A 10	-	Q8DU-05A FFM - QL8A 10	-	Q8U-06A FFM - QL8A 10	-
Q8DU-04B FFA - QL8001 *	Q8SDU-04B FFA - QL8001 *	Q8U-05B FFA - QL8001 *	-	Q8DU-05B FFA - QL8001 *	-	Q8U-06B FFA - QL8001	-

Mating

Pair

***Upon Request**

¹⁾ Standard Lengths: 1M, 2M, 3M, 4M, 5M and 10M. Higher MOQ Might Be Required For Non-Standard Lengths

Assembly Instruction Solder Type

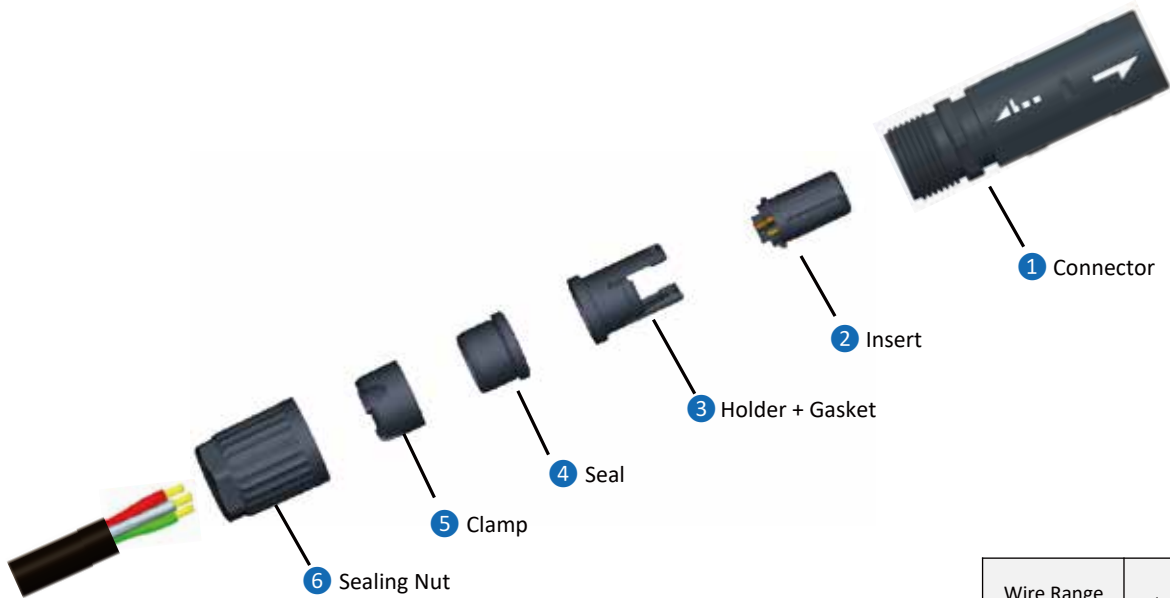

Wire Range	24 ~ 20 AWG (0.25 ~ 0.50 mm ²)
Cable O.D. (Unit: mm)	5.2 ~ 6.0

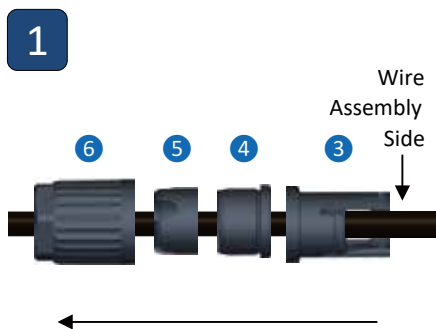

Follow the order from ⑥ to ③ and put components through cable accordingly, no need to assemble here.

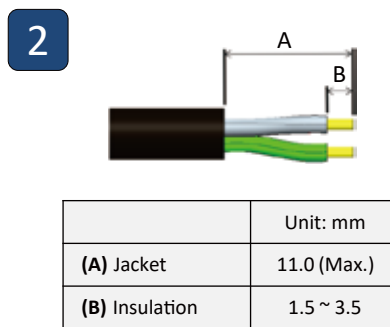

Follow suggested stripping length of (A) Jacket, (B) Insulation

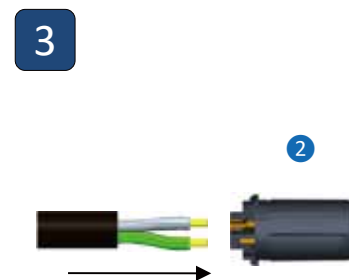

Solder wires onto contacts.

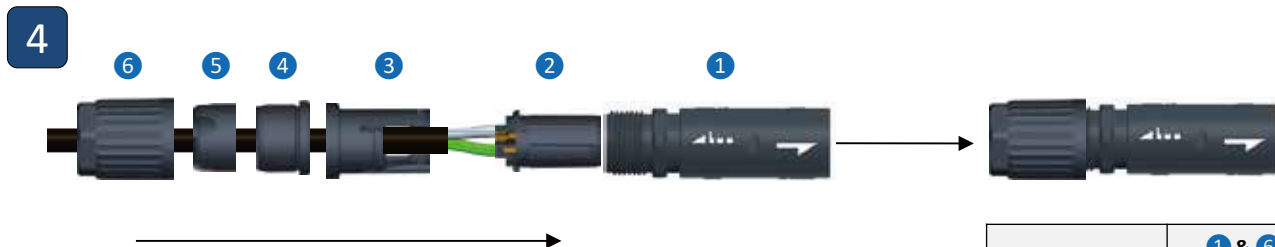

Follow the order ③ → ②, ⑤ → ④, ② & ④ → ① to assemble all components. And tighten ⑥ & ① with suggested torque force.

	① & ⑥
Torque Force (Unit: kgf-cm)	3.0 ~ 5.0

Cable List

Item No.	Jacket	Color	UL No.	Cable Specification	Cable OD	Copper Index (kg/km)	Weight (kg/km)
WCA00011181	PVC	Black	SJTW	12AWG*2C+Filler	10.70	60.80	163.10
WCA00011226	PVC	Black	SJTW	12AWG*3C	11.20	89.60	222.90
WCA00011182	PVC	Black	SJTW	12AWG*3C+Filler	11.70	89.85	207.67
WCA00011243	PVC	Black	UL2464	12AWG*3C+Filler	10.00	90.00	164.40
WCA00011242	PVC	Black	UL2464	12AWG*4C+Filler	11.00	120.40	228.70
WCA00012002	PVC	Black	SJTW	12AWG*4C+Filler	12.30	122.00	293.00
WCA00011183	PVC	Black	SJTW	12AWG*5C+Filler	13.60	149.50	328.90
WCA00010846	PVC	Black	UL1277,UL1581&UL83	14AWG*3C	9.70	53.80	134.20
WCA0485XX01	PVC	Black	UL2464	14AWG*3C+Talcum	7.00	55.80	100.10
WCA00011884	PU	Black	UL20234	14AWG*5C+Filler+Paper	10.00	115.70	180.00
WCA00012012	PU	Black	UL20234	14AWG*5C+Filler+Paper	10.00	115.70	180.00
WCA00011201	PVC	Black	UL21388	16AWG*2C+AL/Mylar	8.20	23.80	60.20
WCA00011206	PVC	Black	SJTW	16AWG*2C+Filler	8.20	24.25	85.10
WCA0264UV01	PVC	Black	UL2464	16AWG*2C+Talcum	5.80	23.80	57.70
WCA00010942	PVC	Black	UL2464	16AWG*2C+Talcum	7.80	24.20	95.00
WCA00010625	PVC	Black	UL2464	16AWG*3C+AL.Mylar+Drain	7.50	46.80	96.60
WCA00011202	PVC	Black	UL21388	16AWG*3C+AL/Mylar	8.60	35.70	71.50
WCA0579UV01	PVC	Black	UL2464	16AWG*3C+Drain+AL.Mylar	7.50	46.70	97.90
WCA00011207	PVC	Black	SJTW	16AWG*3C+Filler	8.60	36.02	105.21
WCA0285UV01	PVC	Black	UL2464	16AWG*4C+AL.Mylar	7.50	47.60	99.90
WCA00011203	PVC	Black	UL21388	16AWG*4C+AL/Mylar	9.30	47.60	88.40
WCA00011208	PVC	Black	SJTW	16AWG*4C+Filler	9.30	49.00	131.50
WCA00011204	PVC	Black	UL21388	16AWG*5C+AL/Mylar	10.70	59.40	99.80
WCA0263UV01	PVC	Black	UL2464	16AWG*5C+Talcum	7.80	59.50	108.80
WCA00011205	PVC	Black	UL21388	16AWG*6C+AL/PET	11.70	71.30	123.30
WCA0582UV01	PVC	Black	UL2464	16AWG*6C+Filler+Drain+AL.Mylar	9.50	82.10	153.60
WCA0583UV01	PVC	Black	UL2464	16AWG*7C+Drain+AL.Mylar	9.50	93.60	175.70
WCA00011299	PVC	Black	UL2464	18AWG*10C	9.00	77.00	145.00
WCE00010070-43	PVC	Black	UL21996	18AWG*2C+Talcum	3.4*5.3	14.82	36.97
WCE00010074-43	PVC	White	UL21996	18AWG*2C+Talcum	3.4*5.3	14.82	36.97
WCA00010897	PVC	Black	UL1277, UL15, 81&UL83	18AWG*3C	8.50	21.30	81.93
WCA00011209	PVC	Black	SJTW	18AWG*3C+Filler	8.00	21.30	81.93
WCA00010898	PVC	Black	UL1277, UL15, 81&UL83	18AWG*4C	9.20	35.00	125.00
WCE00010071-43	PVC	Black	UL21996	18AWG*4C+Talcum	3.4*9.2	29.64	68.14
WCE00010075-43	PVC	White	UL21996	18AWG*4C+Talcum	3.4*9.2	29.64	68.14
WCA00011240	PVC	Black	UL2464	20AWG*10C+AL.Mylar+Filler	9.00	48.00	116.40
WCA00011192	PVC	Black	UL21388	20AWG*10C+AL/Mylar	8.50	48.00	109.70
WCA00011436	PVC	Black	UL2464	20AWG*12C+AL.Mylar+Filler	9.00	57.60	125.10
WCA00011193	PVC	Black	UL21388	20AWG*12C+AL/Mylar	8.50	57.60	121.70
WCA00011200	PVC	Black	UL21388	20AWG*14C+AL/Mylar	8.50	67.20	130.60
WCA0470XX01	PVC	Black	UL2464	20AWG*14C+Braid	9.50	87.90	161.30
WCA0153XX01	PVC	Black	UL2464	20AWG*18C+AL.Mylar	9.50	86.40	154.20
WCA00011581-43	PVC	Black	UL 21996	20AWG*2C	5.20	9.40	34.02
WCA00011194	PVC	Black	UL21388	20AWG*18C+AL/Mylar	10.00	86.40	174.70
WCA00010781	PVC	Black	UL2464	20AWG*2C+AL.Mylar+Braid	5.50	17.70	41.60
WCA00011184	PVC	Black	UL21388	20AWG*2C+AL/Mylar	5.50	9.60	27.40
WCA0124UV01	PVC	Black	UL2464	20AWG*2C+Drain+AL.Mylar	5.80	14.40	48.40
WCE00010072-43	PVC	Black	UL21996	20AWG*2C+Talcum	3.2*5.0	14.10	41.45
WCE00010076-43	PVC	White	UL21996	20AWG*2C+Talcum	3.2*5.0	14.10	41.45
WCA00011580-43	PVC	Black	UL 21996	20AWG*3C	5.50	14.10	41.45
WCA0489UV01	PVC	Black	UL2464	20AWG*3C+AL.Mylar	5.00	14.40	39.30
WCA00010602	PVC	Black	UL2464	20AWG*3C+AL.Mylar+Braid+Drain	5.50	29.20	61.90
WCA00011185	PVC	Black	UL21388	20AWG*3C+AL/Mylar	5.50	14.40	43.70
WCA00011548-43	PVC	Black	UL 21996	20AWG*4C	6.00	18.80	48.46
WCA00011186	PVC	Black	UL21388	20AWG*4C+AL/Mylar	6.00	19.20	51.40
WCA0575UV01	PVC	Black	UL2464	20AWG*4C+Drain+AL.Mylar	5.50	24.00	52.10
WCE00010073-43	PVC	Black	UL21996	20AWG*4C+Talcum	3.2*8.5	18.80	53.34
WCE00010077-43	PVC	White	UL21996	20AWG*4C+Talcum	3.2*8.5	18.80	53.34
WCA00011187	PVC	Black	UL21388	20AWG*5C+AL/Mylar	6.20	24.00	59.20
WCA0576UV01	PVC	Black	UL2464	20AWG*5C+Drain+AL.Mylar	6.00	28.80	62.70
WCA00011188	PVC	Black	UL21388	20AWG*6C+AL/Mylar	6.80	28.80	71.80
WCA0577UV01	PVC	Black	UL2464	20AWG*6C+Drain+AL.Mylar	6.50	33.60	76.80
WCA00011189	PVC	Black	UL21388	20AWG*7C+AL/Mylar	6.80	33.60	75.80
WCA00010049	PVC	Black	UL2464	20AWG*7C+Drain+AL.Mylar	6.50	38.40	74.80
WCA00010550	PVC	Black	UL2464	20AWG*8C+AL.Mylar+Drain+Filler	6.80	43.00	86.00

Cable List

Item No.	Jacket	Color	UL No.	Cable Specification	Cable OD	Copper Index (kg/km)	Weight (kg/km)
WCA00011190	PVC	Black	UL21388	20AWG*8C+AL/Mylar	7.20	38.40	87.00
WCA00011489-28	PVC	Black	UL2464	20AWG*9C+AL.Mylar+Drain	7.40	48.50	101.80
WCA00011191	PVC	Black	UL21388	20AWG*9C+AL/Mylar	7.60	43.20	97.30
WCA00010868	PVC	Black	UL2464	22AWG*2C+Talcum	4.20	6.20	24.60
WCA00011339	PVC	Yellow	UL2517	22AWG*3C	4.50	9.00	31.50
WCA00011343	PU	Black	UL20549	22AWG*3C	3.80	9.00	26.00
WCA00011459-28	PVC	Black	UL2517	22AWG*3C	4.50	9.30	31.00
WCA00010063	PU	Black	NONUL	22AWG*3C+Talcum	4.50	9.00	26.40
WCA0570UV01	PVC	Black	UL2464	22AWG*3C+Talcum	5.00	9.30	35.20
WCA00011340	PVC	Yellow	UL2517	22AWG*4C	4.80	11.70	40.00
WCA00011344	PU	Black	UL20549	22AWG*4C	4.00	12.00	31.80
WCA00011460-28	PVC	Black	UL2517	22AWG*4C	4.80	12.00	38.00
WCA00011813-01	PVC	Black	UL2517	22AWG*4C+AL.Mylar+Braid	5.30	22.00	46.00
WCA00011872	PU	Black	UL20549	22AWG*4C+AL.Mylar+Braid+Paper	5.30	22.00	48.00
WCA00010062	PU	Black	NONUL	22AWG*4C+Insulation	4.80	12.00	29.40
WCA0571UV01	PVC	Black	UL2464	22AWG*4C+Talcum	5.00	12.40	38.60
WCA00011341	PVC	Yellow	UL2517	22AWG*5C	5.10	15.50	43.80
WCA00011687-01	PVC	Black	UL2517	22AWG*5C+AL.Mylar+Filler+Braid	5.70	26.00	58.00
WCA00011345	PU	Black	UL20549	22AWG*5C+Filler	4.40	15.00	43.50
WCA00011461-28	PVC	Black	UL2517	22AWG*5C+Filler	5.10	15.00	43.00
WCA00011870	PU	Black	UL20549	22AWG*5C+Filler+AL.Mylar+Braid+Paper	5.70	26.00	51.00
WCA00012245	PU	Black	UL20549	22AWG*5C+Filler+Paper	5.60	19.00	51.00
WCA00010061	PU	Black	NONUL	22AWG*5C+Filler+Talcum+Paper	5.00	15.50	38.50
WCA0352XX02	PU	Black	NONUL	22AWG*5C+Talcum	5.00	15.50	47.50
WCA0521UV01	PVC	Black	UL2464	22AWG*5C+Talcum	5.50	15.50	47.50
WCA0556UV01	PVC	Black	UL2464	24AWG*10C+Drain+AL.Mylar	6.50	22.00	63.80
WCA0557UV01	PVC	Black	UL2464	24AWG*12C+Drain+AL.Mylar	7.00	26.00	72.30
WCA0558UV01	PVC	Black	UL2464	24AWG*14C+Drain+AL.Mylar	7.00	30.00	77.10
WCA0465UV01	PVC	Black	UL2464	24AWG*15C+Drain+AL.Mylar	7.00	32.00	77.60
WCA0560UV01	PVC	Black	UL2464	24AWG*18C+Drain+AL.Mylar	8.00	38.00	100.70
WCA0284UV01	PVC	Black	UL2464	24AWG*25C+Drain+AL.Mylar	9.00	51.90	130.90
WCA0072UV01	PVC	Black	UL2464	24AWG*2C+Drain+AL.Mylar	4.20	6.00	24.00
WCA0027UV01	PVC	Black	UL2464	24AWG*2C+Talcum	4.20	4.00	22.70
WCA00010114	PVC	Black	UL2464	24AWG*37C+Drain+AL/Mylar	9.50	74.00	153.20
WCA00011746-03	PVC	Black	UL2517	24AWG*3C+AL.Mylar+Braid	4.60	13.10	31.30
WCA0549UV01	PVC	Black	UL2464	24AWG*3C+Drain+AL.Mylar	4.50	8.00	29.00
WCA0006UV01	PVC	Black	UL2464	24AWG*3C+Talcum	4.50	6.00	27.70
WCA00011726-03	PVC	Black	UL2517	24AWG*4C+AL.Mylar+Braid	5.00	16.40	38.50
WCA0219UV01	PVC	Black	UL2464	24AWG*4C+Drain+AL.Mylar	5.80	10.00	45.60
WCA0036UV01	PVC	Black	UL2464	24AWG*4C+Talcum	5.00	8.00	32.40
WCA00011584-43	PVC	Black	UL 21996	24AWG*5C	5.50	9.88	41.20
WCA0551UV01	PVC	Black	UL2464	24AWG*5C+Drain+AL.Mylar	5.00	12.00	37.00
WCA0229UV01	PVC	Black	UL2464	24AWG*5C+Talcum	5.00	10.00	34.40
WCA00011583-43	PVC	Black	UL 21996	24AWG*6C	5.80	11.86	45.21
WCA00011214	PVC	Black	UL2464	24AWG*6C+AL.Mylar	5.00	12.00	39.40
WCA0217UV01	PVC	Black	UL2464	24AWG*6C+Drain+AL.Mylar	5.80	14.00	45.00
WCA00011479-28	PVC	Black	UL2517	24AWG*6C+Filler	5.00	12.00	40.00
WCA00012067	PVC	Black	UL21388	24AWG*6C+Filler+AL.Mylar	5.20	11.40	35.40
WCA00011421	PVC	Yellow	UL2517	24AWG*6C+Filler+Talcum	5.00	17.60	49.20
WCA00011422	PU	Black	UL20549	24AWG*6C+Filler+Talcum	5.00	13.00	34.00
WCA0087UV01	PVC	Black	UL2464	24AWG*7C+Drain+AL/Mylar	5.80	16.00	51.00
WCA00011342	PVC	Yellow	UL2517	24AWG*8C	5.50	15.50	48.00
WCA00011346	PU	Black	UL20549	24AWG*8C	4.80	15.50	35.00
WCA00011462-28	PVC	Black	UL2517	24AWG*8C	5.50	15.50	48.00
WCA00011698-01	PVC	Black	UL2517	24AWG*8C+AL.Mylar+Filler+Braid	5.80	27.00	60.00
WCA0003UV01	PVC	Black	UL2464	24AWG*8C+Drain+AL/Mylar	5.50	18.00	45.70
WCA00012066	PVC	Black	UL21388	24AWG*8C+Filler+AL.Mylar	5.60	15.20	43.40
WCA00011814-01	PU	Black	UL20549	24AWG*8C+Filler+AL.Mylar+Braid+Paper	5.80	26.00	51.00
WCA00012341	PU	Black	UL20549	24AWG*8C+Filler+Paper	6.70	19.00	65.00
WCA0203UV01	PVC	Black	UL2464	24AWG*8C+Talcum	5.50	16.00	45.30
WCA0528UV01	PVC	Black	UL2464	24AWG*9C+Drain+AL.Mylar	6.00	20.00	54.80
WCA0540UV01	PVC	Black	UL2464	26AWG*6C+Drain+AL.Mylar	5.00	9.80	33.70
WCA0543UV01	PVC	Black	UL2464	26AWG*10C+Drain+AL.Mylar	6.00	15.00	50.30
WCA00011400	PU	Black	UL20549	26AWG*10C+Filler	6.00	14.00	48.00
WCA00011401	PVC	Yellow	UL2517	26AWG*10C+Filler	6.00	14.00	52.00

Cable List

Item No.	Jacket	Color	UL No.	Cable Specification	Cable OD	Copper Index (kg/km)	Weight (kg/km)
WCA00011463-01	PVC	Black	UL2517	26AWG*10C+Filler	6.00	14.00	52.00
WCA00011380	PU	Black	UL20549	26AWG*12C	6.00	16.00	47.00
WCA00011402	PVC	Yellow	UL2517	26AWG*12C	6.00	17.00	54.00
WCA00011464-01	PVC	Black	UL2517	26AWG*12C	6.00	17.00	55.00
WCA00011782-01	PVC	Black	UL2517	26AWG*12C+AL.Mylar+Braid	6.40	25.00	63.00
WCA00011871	PU	Black	UL20549	26AWG*12C+AL.Mylar+Braid+Paper	6.40	28.00	60.00
WCA0544UV01	PVC	Black	UL2464	26AWG*12C+Drain+AL.Mylar	6.00	17.60	53.10
WCA0545UV01	PVC	Black	UL2464	26AWG*15C+Drain+AL.Mylar	6.50	21.50	58.70
WCA00012148	PU	Black	UL20549	26AWG*17C+Filler	7.00	23.00	63.00
WCA00012173	PVC	Yellow	UL2517	26AWG*17C+Filler	7.00	24.00	73.00
WCA00012149	PVC	Black	UL2517	26AWG*17C+Filler	7.00	24.00	68.00
WCA00012151	PVC	Black	UL2517	26AWG*17C+Filler+AL.Mylar+Braid	7.50	40.00	91.00
WCA00012150	PU	Black	UL20549	26AWG*17C+Filler+AL.Mylar+Braid+Paper	7.50	39.00	80.00
WCA00010045	PVC	Black	UL2464	26AWG*22C+Drain+AL.Mylar	7.50	29.90	78.10
WCA0546UV01	PVC	Black	UL2464	26AWG*26C+Drain+AL.Mylar	8.00	35.80	91.30
WCA0449UV01	PVC	Black	UL2464	26AWG*31C+Drain+AL.Mylar	9.00	42.30	117.40
WCA0481UV01	PVC	Black	UL2464	26AWG*3C+Drain+AL.Mylar	4.00	5.20	22.40
WCA0547UV01	PVC	Black	UL2464	26AWG*44C+Drain+AL.Mylar	10.50	59.20	157.10
WCA0487UV01	PVC	Black	UL2464	26AWG*4C+Drain+AL.Mylar	4.80	7.20	30.80
WCA0486UV01	PVC	Black	UL2464	26AWG*5C+Drain+AL.Mylar	4.80	8.50	33.00
WCA00011480-01	PU	Black	-	CAT.5E 22AWG*2P+Drain+Filler+AL.Mylar	6.20	14.00	44.00
WCA00011527-17	LSZH	Green	-	CAT.6A S/FTP 26AWG*4P+AL/Polyester+Braid	6.60	17.99	47.08
WCA00010840	PVC	Black	-	CAT5E FTP 24AWG*4P+Mylar+D+AL.Mylar	6.50	17.97	47.34
WCA0373XX01	PVC	Beige	-	CAT5E FTP 24AWG*4P+Mylar+D+AL.Mylar	6.00	18.00	41.80
WCA0664UV01	PVC	Black	-	CAT5E FTP 24AWG*4P+Mylar+D+AL/Mylar	6.50	18.00	52.30
WCA0459XX01	PVC	Beige	-	CAT5E S-FTP 24AWG*4P+Mylar+AL.Mylar+D+B	6.10	30.97	55.00
WCA0663UV01	PVC	Black	-	CAT5E UTP 24AWG*4P	6.00	16.00	49.40
WCA00011688-03	PVC	Yellow	-	CL2 22AWG*2C+AL.Mylar+Drain+Braid	5.80	16.70	49.80
WCA0611XX01	PVC	Black	-	SJTW 14AWG*3C	9.50	56.70	154.50
WCA00010369	PVC	Black	-	STOOW 16AWG*4C	10.60	49.00	181.00
WCA00010899	PVC	Black	UL1277,UL1581,UL83	14AWG*3C+16AWG*1C	10.30	68.48	172.00
WCA00011252	PU	Black	UL20549	18AWG*2C+22AWG*4C+Filler+Paper	6.00	27.50	63.00
WCA00011253	PU	Black	UL20549	18AWG*2C+22AWG*6C+Filler+Paper	7.40	33.60	83.00
WCA00011254	PU	Black	UL20549	18AWG*2C+22AWG*8C+Filler+Paper	8.20	40.00	98.00
WCA00011582-43	PVC	Black	UL 21996	20AWG*2C+20AWG*3C	6.00	15.33	50.21
WCA0585UV01	PVC	Black	UL2464	24AWG*4C+20AWG*2C+Drain+AL.Mylar	6.00	22.40	57.40
WCA0042UV01	PVC	Black	UL2464	24AWG*6C+20AWG*2C+Drain+AL.Mylar	6.00	26.20	58.50
WCA0584UV01	PVC	Black	UL2464	26AWG*6C+24AWG*2C+Drain+AL.Mylar	5.50	13.70	42.80
WCA0365UV01	PVC	Black	-	28AWG*1P+24AWG*2C+AL.Mylar+Drain+Braid (USB2.0)	5.00	11.90	35.10
WCA00012165	PVC	Black	UL2725	28AWG*1P+28AWG*2C+AL.Mylar+Drain+Braid	3.80	10.00	21.00
WCA0691XX01	PVC	Black	UL2725	28AWG*1P+28AWG*3C+AL.Mylar+Drain+Braid	3.80	10.40	23.20
WCA00010259	PVC	Black	UL20276	[(18AWG*1P+AL)+(16AWG*1P+AL)]+Drain+AL+Braid	10.00	73.00	152.00
WCA00011922	PVC	Black	UL21996	(20AWG*1P+Drain+AL.Mylar)+16AWG*3C+Filler+AL.Mylar	8.50	50.61	115.27
WCA00010258	PVC	Black	-	[(22AWG+1P+AL)+(18AWG+1P+AL)]+Drain+AL.Mylar+Braid	7.00	42.00	80.00
WCA00010876	PVC	Black	UL2586	(24AWG*1P+A)*2C+16AWG*3C+EA	10.00	47.00	128.00
WCA00010257	PVC	Black	-	[(24AWG+1P+AL)+(22AWG+1P+AL)]+Drain+AL.Mylar+Braid	6.00	27.00	58.00
WCA00011350	PVC	Black	-	[(24AWG+1P+AL)+(22AWG+1P+AL)]+Drain+AL.Mylar+Braid	6.70	29.70	65.80
WCA00010437	PVC	Gray	-	[(24AWG+1P+AL)+(22AWG+1P+AL)]+Drain+Braid+Mylar	7.10	14.80	69.80
WCA00010080	PVC	Black	UL2464	(24AWG*25C+Mylar)+24AWG*25C+Drain+AL.Mylar	12.00	110.00	285.00
WCA00010710	PVC	Black	UL2464	(24AWG*2P+Drain+AL)+16AWG*3C+Filler+Paper	12.00	45.70	179.10
WCA00011923	PVC	Black	UL21996	(24AWG*2P+Drain+AL.Mylar)+12AWG*3C+Filler+AL.Mylar	11.50	99.97	187.20
WCA00010635	PVC	Black	UL2464	(24AWG*4P+Drain+AL)+16AWG*3C+Filler+Paper	11.00	41.70	149.70
WCA00010264	PVC	Black	UL20276	(26AWG*1P+Drain+AL.Mylar)*4C+26AWG*1P+26AWG*5C+AL.Mylar+Braid	8.50	45.50	94.30
WCA00011530-43	PVC	Black	UL21996	(26AWG*2P+AL.Mylar)+16AWG*2C+Filler+AL.Mylar	9.30	28.54	106.26
WCA00011531-43	PVC	Black	UL21996	(26AWG*2P+Drain+AL.Mylar)+16AWG*3C+Filler+AL.Mylar	11.00	41.58	146.60
WCA00011532-43	PVC	Black	UL21996	(26AWG*4P+Drain+AL.Mylar)+12AWG*3C+Filler+AL.Mylar	13.50	101.34	269.21
WCA00012137	PVC	Black	UL2725	(28AWG*1P+DAM)*2+28AWG*1P+28AWG*2C+Filler+AL.Mylar+Drain+Braid	6.00	21.80	48.20
WCA00010095	PVC	Black	UL20276	(28AWG*1P+Drain+AL+Mylar)*4C+(1P+3C)*28AWG+AL+Braid	7.30	33.90	73.70
WCA00010097	PVC	Black	UL20276	(28AWG*1P+Drain+AL+Mylar)*7C+28AWG*1P+28AWG*3C+AL+Braid	8.50	41.40	90.90
WCA00010081	PVC	Black	UL2464	[(28AWG*28C+Mylar)+28AWG*22C+Mylar]+28AWG*28C+Drain+AL	13.00	63.70	238.40
WCA00010096	PVC	Black	UL20276	[3COAX+(28AWG*1P+Drain+AL.Mylar+Mylar)*4+28AWG*1P+28AWG*6C]+AL.Mylar+Braid	8.50	53.50	93.10
WCA00010098	PVC	Black	UL20276	[3COAX+(28AWG*1P+Drain+AL+Mylar)*7+28AWG*1P+28AWG*6C]+AL+Braid	10.00	71.00	145.50
WCA00011960	PU	Black	UL20233	5C*2.5mm ² +Filler+Paper	10.20	116.00	191.00
WCA00011175	PU	Black	UL20549	8C*0.34mm ² +3C*1.0mm ² +Filler	8.60	54.00	116.00
WCA00011176	PU	Black	UL20549	16C*0.34mm ² +3C*1.0mm ² +Filler	9.70	79.00	161.00

Power-limited Circuit Cable

Specifications

- Rated Voltage: 300V
- Temperature Range: FEP: 70 °C
PVC: 60 °C, 75 °C
- Test Voltage: 900V AC at 2 seconds
- Conductor Range: 28AWG ~ 10AWG
- Conductor Material Available: Standard Bare Copper
- Insulator Material Available: FEP/PVC
- Jacket Material: FEP/PVC
- O.D. Tolerance: > Ø17.8 mm



(UL) E489959-N CLXX XX AWG XX°C 300V

CLXX: UL13 Cable Type
 • Plenum Rated: (2P), (3P)
 • Riser Rated: (2R), (3R)
 • General Rated: (2), (3)
 • Residential Rated: (2X), (3X)

XX°C: Temperature Rating
 • FEP: (70)
 • PVC: (60), (75)

Features & Applications:

Type	Fire Resistance Level	UL Standard	CSA	Application
CL3P CL2P	Plenum Rated (Highest)	UL 910, CMP	FT6	• Ducts or plenums air handling space
CL3R CL2R	Riser Rated	UL 1666, CMR	-	• Vertical shafts in non-plenum areas • Cable runs through more than one floor
CL3 CL2	General Purpose Rated	UL 1685, CMG/CM	FT4	• Power-limited circuit cable in non-plenum areas • Cable runs within one floor
CL3X CL2X	Residential Rated (Lowest)	VW-1, CMX	-	• Enclosed in non-plenum raceway or noncombustible tubing • Cable runs within one floor

Notes: UL File Number E489959; round or flat cable available

Find Our Standard Products

Part Number	WCA00011262	WCA00011263	WCA00011435	WCA00011282	WCA00011283*	WCA00011272	WCA00011324
Cable Type	CL3P	CL3P	CL3P	CL3P	CL3P	CL3P	CL3P
Conductor	AWG	10	16	16	16	18	22
	No.	2	2	2	8	2	2
	Dia.	2.6	1.3	1.3	1.3	1.3	0.64
Insulation	Nom. Thick.	0.25mm	0.27mm	0.27mm	0.27mm	0.27mm	0.25mm
	Nom. Dia.	3.5±0.1mm	2.00±0.1mm	2.00±0.1mm	2.00±0.1mm	2.00±0.1mm	1.12±0.05mm
Jacket	Nom. Thick.	0.8mm	0.58mm	0.58mm	0.69mm	0.56mm	0.46mm
	Nom. Dia.	8.8±0.3mm	5.2±0.3mm	5.2±0.3mm	8.0±0.3mm	11.0±0.5mm	3.4±0.15mm
Conductor Resistance at 20°C (Max.)	3.41Ω/km	13.7Ω/km	13.7Ω/km	13.7Ω/km	13.7Ω/km	21.9Ω/km	55.4Ω/km

* Upon Request

Other cable types and customization are available upon request.

UL 21996 Multiple-Conductor Cable Using Non-Integral Jacket

Specifications

- Rated Voltage: 300V
- Temperature Range: -40°C ~ 105°C
- Test Voltage: 2000V AC at 1 minute
- Wet Temperature Rating: 60°C (Max.)
- Conductor Range: 30AWG ~ 10AWG
- Conductor Material Available: Tinned Copper
- Insulator Material Available: FEP/PVC
- Shielding Material Available: AL/Mylar: Coverage 100%, Overlap 25% (Min.)
Braid: Tinned Copper, Overlap 65% (Min.)
Spiral: Tinned Copper, Overlap 90% (Min.)
- Jacket Material: PVC
- O.D. Tolerance: > Ø17.8 mm
- Impedance: 100Ω ~ 120Ω ±15Ω



E489039-D VW AWM 21996 XX AWG -40°C 105°C 300V VW-1 AWM I/II A/B -40°C 105°C 300V FT1 Sun Res Wet 60°C Cable

Application

Internal wiring and external interconnection of electronic equipment. Suitable for outdoor use.

Features

- Reference standard: UL Subject 758, UL1581 & CSA C22.2 No.210.2
- Lead free PVC jacket
- Wide temperature range
- Sunlight resistant
- Passes UL VW-1(horizontal) & CSA FT1 (vertical) flammability tests
- Round or flat cable available
- Mixture, individual or paired conductors available
- UL File Number: E489039

Find Our Standard Products

Single Insulated Conductor Cable

Part Number		WCA00011581-43	WCA00011580-43	WCA00011548-43	WCA00011584-43	WCA00011583-43
Conductor	AWG	20	20	20	24	24
	No.	2	3	4	5	6
	Dia.	0.942mm	0.942mm	0.942mm	0.609mm	0.609mm
Insulation	Nom. Thick.	0.38mm	0.38mm	0.38mm	0.35mm	0.35mm
	Nom. Dia.	1.70±0.10mm	1.70±0.10mm	1.70±0.10mm	1.30±0.07mm	1.30±0.07mm
Shield	Style	-	-	-	-	Paper
	Overlap	-	-	-	-	25%
Conductor Resistance at 20°C (Max.)		34.6 / km	34.6 / km	34.6 / km	93.0 / km	93.0 / km
Jacket	Nom. Thick.	0.98mm	0.92mm	0.95mm	0.92mm	0.95mm
	Nom. Dia.	5.2±0.15mm	5.5±0.20mm	6.0±0.20mm	5.5±0.20mm	5.8±0.20mm

UL 21996 Multiple-Conductor Cable Using Non-Integral Jacket

Multi-conductor Cable

Part Number		WCA00011532-43		WCA00011530-43		WCA00011531-43		WCA00011582-43	
Component		A	B	A	B	A	B	A	B
Conductor	AWG	12	26	16	26	16	26	20	24
	No.	3	4	2	2	2	2	2	3
	Dia.	2.365mm	0.480mm	1.490mm	0.480mm	1.490mm	0.480mm	0.942mm	0.609mm
Insulation	Nom. Thick.	0.46mm	0.46mm	0.40mm	0.46mm	0.40mm	0.46mm	0.38mm	0.35mm
	Nom. Dia.	3.30±0.15mm	1.40±0.10mm	2.30±0.10mm	1.40±0.10mm	2.30±0.10mm	1.40±0.10mm	1.70±0.10mm	1.30±0.07mm
Shield	Style	-	Al. Mylar	-	Al. Mylar	-	Al. Mylar	-	Paper
	Overlap	-	25%	-	25%	-	25%	-	25%
Drain	AWG	-	26	-	-	-	26	-	-
	Dia.	-	0.480mm	-	-	-	0.480mm	-	-
Conductor Resistance at 20°C (Max.)		5.54 / km	148.0 / km	13.7 / km	148.0 / km	13.7 / km	148.0 / km	34.6 / km	93.0 / km
Jacket	Nom. Thick.	1.65mm		1.65mm		1.65mm		0.9mm	
	Nom. Dia.	13.5±0.40mm		9.3±0.25mm		11.0±0.30mm		6.0±0.20mm	
Impedance		120±15		120±15		120±15		-	

Customization is available upon request.

UL 21388 Jacket Cable

Specifications

- Rated Voltage: 300V
- Temperature Range: ~ 80°C
- Test Voltage: 2000V AC at 1 minute
- Conductor Range: 30AWG ~ 10AWG
- Conductor Material Available: Tinned Copper
- Insulator Material Available: FEP/PVC/PE
- Shielding Material Available: AL/Mylar: Coverage 100%, Overlap 25% (Min.)
Braid: Tinned Copper, Overlap 65% (Min.)
Spiral: Tinned Copper, Overlap 90% (Min.)
- Jacket Material: PVC
- O.D. Tolerance: > Ø17.8 mm
- Impedance: 100Ω ~ 120Ω ±15Ω



E489039-D AWM 21388 XX AWG 80°C 300V VW-1 AWM I/II A/B 80°C 300V FT1 Sun Res Cable

Application

Internal wiring and external interconnection of electronic equipment. Suitable for outdoor use.

Features

- Reference standard: UL Subject 758, UL 1581 & CSA C22.2 No.210.2
- Lead free PVC jacket
- Wide temperature range
- Sunlight resistant
- Passes UL VW-1(horizontal) & CSA FT1 (vertical) flammability tests
- Round or flat cable available
- Mixture, individual or paired conductors available
- UL File Number: E489039

Find Our Standard Products

Part Number		WCA00011201	WCA00011202	WCA00011203	WCA00011204	WCA00011205	WCA00011184
Conductor	AWG	16	16	16	16	16	20
	No.	2	3	4	5	6	2
	Dia.	1.496mm	1.496mm	1.496mm	1.496mm	1.496mm	0.953mm
Insulation	Nom. Thick.	0.23mm	0.23mm	0.23mm	0.23mm	0.23mm	0.23mm
	Nom. Dia.	2.10±0.10mm	2.10±0.10mm	2.10±0.10mm	2.10±0.10mm	2.10±0.10mm	1.50±0.10mm
Shield	Style	Al. Mylar	Al. Mylar	Al. Mylar	Al. Mylar	Al. Mylar	Al. Mylar
	Overlap	25%	25%	25%	25%	25%	25%
Jacket	Nom. Thick.	0.76mm	0.76mm	0.76mm	0.76mm	0.76mm	0.76mm
	Nom. Dia.	6.00±0.20mm	6.50±0.20mm	6.80±0.20mm	7.60±0.20mm	8.40±0.20mm	5.50±0.20mm
Conductor Resistance at 20°C (Max.)		14.7 / km	14.7 / km	14.7 / km	14.7 / km	14.7 / km	36.7 / km

UL 21388 Jacket Cable

Find Our Standard Products

Part Number		WCA00011185	WCA00011186	WCA00011187	WCA00011188	WCA00011189	WCA00011190
Conductor	AWG	20	20	20	20	20	20
	No.	3	4	5	6	7	8
	Dia.	0.953mm	0.953mm	0.953mm	0.953mm	0.953mm	0.953mm
Insulation	Nom. Thick.	0.23mm	0.23mm	0.23mm	0.23mm	0.23mm	0.23mm
	Nom. Dia.	1.50±0.10mm	1.50±0.10mm	1.50±0.10mm	1.50±0.10mm	1.50±0.10mm	1.50±0.10mm
Shield	Style	Al. Mylar	Al. Mylar	Al. Mylar	Al. Mylar	Al. Mylar	Al. Mylar
	Overlap	25%	25%	25%	25%	25%	25%
Jacket	Nom. Thick.	0.76mm	0.76mm	0.76mm	0.76mm	0.76mm	0.76mm
	Nom. Dia.	5.50±0.20mm	6.00±0.20mm	6.20±0.20mm	6.80±0.20mm	6.80±0.20mm	7.20±0.20mm
Conductor Resistance at 20°C (Max.)		36.7 / km	36.7 / km	36.7 / km	36.7 / km	36.7 / km	36.7 / km

Part Number		WCA00011191	WCA00011192	WCA00011193	WCA00011200	WCA00011194
Conductor	AWG	20	20	20	20	20
	No.	9	10	12	14	18
	Dia.	0.953mm	0.953mm	0.953mm	0.953mm	0.953mm
Insulation	Nom. Thick.	0.23mm	0.23mm	0.23mm	0.23mm	0.23mm
	Nom. Dia.	1.50±0.10mm	1.50±0.10mm	1.50±0.10mm	1.50±0.10mm	1.50±0.10mm
Shield	Style	Al. Mylar	Al. Mylar	Al. Mylar	Al. Mylar	Al. Mylar
	Overlap	25%	25%	25%	25%	25%
Jacket	Nom. Thick.	0.76mm	0.76mm	0.76mm	0.76mm	0.76mm
	Nom. Dia.	7.60±0.20mm	8.50±0.25mm	8.50±0.25mm	8.50±0.20mm	10.0±0.30mm
Conductor Resistance at 20°C (Max.)		36.7 / km	36.7 / km	36.7 / km	36.7 / km	36.7 / km

Customization is available upon request.

UL 2464 Multiple-Conductor Cable Using Non-Integral Jacket

Specifications

- Rated Voltage: 300V
- Temperature Range: ~ 80°C
- Test Voltage: 2000V AC at 1 minute
- Conductor Range: 30AWG ~ 10AWG
- Conductor Material Available: Tinned Copper
- Insulator Material Available: FEP/PVC/PE
- Shielding Material Available: AL/Mylar: Coverage 100%, Overlap 25% (Min.)
Braid: Tinned Copper, Overlap 65% (Min.)
Spiral: Tinned Copper, Overlap 90% (Min.)
- Jacket Material: PVC
- O.D. Tolerance: > Ø17.8 mm
- Impedance: 100Ω ~ 120Ω ±15Ω



E489039-D  AWM 2464 XX AWG 80°C 300V VW-1  AWM I/II A/B 80°C 300V FT1 Cable

Application

Internal wiring and external interconnection of electronic equipment. Suitable for outdoor use.

Features

- Reference standard: UL Subject 758, UL 1581 & CSA C22.2 No.210.2
- Lead free PVC jacket
- Wide temperature range
- Sunlight resistant
- Passes UL VW-1(horizontal) & CSA FT1 (vertical) flammability tests
- Round or flat cable available
- Mixture, individual or paired conductors available
- UL File Number: E489039

Question

Our most popular FAQs will help you to easily find the answers you need.



Q: What connectors can be used for power and signal distribution?

A: Ceres, SENSOR, X-Lok, RBL and HS-Lok connectors. For more detailed information and guide, please refer to our "Product Summary Table".

Q: Can ALTW connectors be used in direct burial?

A: No, they are not designed for this type of application. They should be routed inside a conduit or other means of reinforcement if deployed underground.

Q: Can ALTW connectors be used in continuous water immersion?

A: No, there is a limitation for their immersion to water as defined on each IP rating. Only "Deepronica" series can be used in permanent immersion.

Q: Why are ALTW connectors called waterproof if they can only be immersed for a certain period? Shouldn't they be called water resistant?

A: As long as the immersion period does not surpass the conditions specified on the IP rating, they can be referred to as waterproof.

Q: What is the Ingress Protection (IP) of ALTW connectors?

A: It ranges from IP65 to IP69K.

Q: Can ALTW connectors be connected/disconnected under load?

A: By default, only connectors for data (RJ45, DVI, HDMI, and USB) can be used in hot-plugging. Power connectors need to be customized to achieve this.

FAQ

Q: Do ALTW connectors comply with MIL STD?

A: No, ALTW connectors are only evaluated under EIA, IEC and UL standards.

Q: What connectors can be used in high-speed base band data transmission?

A: Ceres, X-Lok, M12 D & X-coded, RJ45, DVI, HDMI, USB and FLOS connectors.

Q: Can ALTW connectors be customized to meet certain requirements?

A: Yes, connectors can be customized to meet customer requirements. If a certification is required, it will be applied. If not, ALTW can provide in-house test reports as a confirmation that the pre-defined specifications have been met.

Q: Do ALTW connectors have ATEX certification?

A: No, ALTW connectors are not yet certified by ATEX.

Q: What is the difference between Oleophobic and Hydrophobic protective vents? What is the main function of the vent?

A: These properties refer to the fluid resistance of the membrane in the vent. Hydrophobic means that the membrane is water repelling, while Oleophobic means the membrane is oil repelling.

They are used in applications that require the balancing of internal and external pressures such as electrical cabinets, wireless access points, control hubs and junction boxes. The trapped air inside the enclosures expands or contracts relative to the heat emitted by the components it encloses and the external ambient temperatures.



If your question is not answered here, please contact Amphenol LTW Customer Service or browse our website for more information.
www.amphenolltw.com

Scan here to contact us or e-mail us at sales@ltw-tech.com

UV Resistant

Being resistant to ultraviolet light (UV), or sunlight, means being able to withstand or resist the degradation caused by ultraviolet light. UV light causes non-resistant materials and surfaces to fade or discolor.

Flammability

The ability of a chemical to burn or ignite, causing fire or combustion. The degree of difficulty required to cause the combustion of a chemical is quantified through fire testing.

Flammability can be classified as low (least flame-retarded) to high (most flame-retarded). From lowest to highest it is classified as follows:

- HB - horizontal slow burning: Burning rate under 76mm/min for a thickness below 3mm or the burning stops before 100mm
 - V-2: Burning stops within 30 seconds on a vertical specimen and drips of flaming particles are allowed
 - V-1: Burning stops within 30 seconds on a vertical specimen and drips of particles are allowed as long as they are not inflamed
 - V-0: Burning stops within 10 seconds on a vertical specimen and drips of particles are allowed as long as they are not inflamed
-

IEC

The International Electrotechnical Commission (IEC) is the world's leading organization for the preparation and publication of international standards for all electrical, electronic and related technologies. These are known collectively as “electrotechnology”.

The IEC provides a platform for companies, industries and governments to meet, discuss and develop the international standards they require. All IEC standards are consensus-based and represent the needs of the key stakeholders of every nation participating. Every member country has a vote on what is included into an IEC international standard.

UL 50e

This standard applies to enclosures for electrical equipment intended to be installed and used in non-hazardous locations. It covers additional environmental construction and performance requirements for enclosures.

UL 1863

This standard applies to Safety Communication - circuit Accessories. It covers telecommunications-circuit accessories, such as jack and plug assemblies, quick-connect terminal assemblies, telephone wall plates, telephone extension cords, cross-connect terminal-block assemblies, maintenance terminal modules, terminal enclosures, cable-splice enclosures, network-interface devices, wire-guide assemblies, and connector boxes.

UL 1977

These requirements cover single and multipole connectors intended for factory assembly to copper or copper alloy conductors or printed wiring boards for use in data, signal, control and power applications within and between electrical equipment.

UL 2237

This standard covers multi-point interconnection power cable assemblies. They may consist of power cable assemblies, male or female power cable fittings, panel-mounted power cable/conductor fittings and feeder-tap power cable fittings, referred to as the device in this standard, used with industrial machinery in accordance with the National Fire Protection Association Electrical Standard for Industrial Machinery, NFPA 79 that have system voltages up to and including 1,000 V.

UL 2238

These requirements cover devices intended for inter-connection of equipment, sensors, and actuators in remote-control, signaling, and power-limited circuits. Included are cable assemblies and fittings, feeder-tap cable systems, feed-through connectors, multi-outlet fittings, panel-mount fittings, and splitters. These devices are rated at no more than 60 A and no more than 600 V. These devices are not intended for disconnect means.

LV214

This automotive standard was developed by German car manufacturers Audi, BMW, Daimler, Porsche and Volkswagen. It addresses the ability of terminals to be effectively evaluated by crimp force monitors. The terminals must exhibit certain crimp force to be used in an automotive wire harness.

Fasten Style of Nut

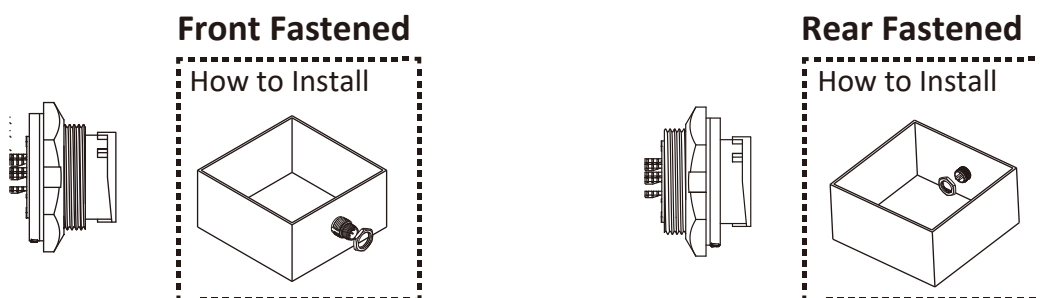

Mating Style

Screw Thread

- Ceres
- RJ45
- Cable Joiner & FICX
- Power
- USB
- M Series
- HDMI
- Cable Gland
- NMEA
- RF
- LED Light Guide
- D-Sub
- DVI
- Vent

2 Points Lock Bayonet

- Ceres
- Power
- USB

3 Points Lock Bayonet

- Ceres
- Power
- RJ45
- Fiber

Push Pull

- M Series
- FLOS & FLOS+
- HS-Lok
- USB

Push Lock With Latches

- RBL
- D-Sub
- SSL

Push Lock

- X-Lok
- USB

Termination Style



PCB 180°



PCB 90°



Solder



Screw In



Crimp



IDC



Push In



SMT

ODVA

ODVA is a global association whose members comprise of world's leading automation companies. ODVA's mission is to advance open, interoperable information and communication technologies in industrial automation. The association recognizes its media independent network protocol, the Common Industrial Protocol or "CIP" – and the network adaptations of CIP – EtherNet/IP, DeviceNet, CompoNet and ControlNet – as its core technology and the primary common interest of its membership.

ODVA's vision is to contribute to the sustainability and prosperity of the global community by transforming the model for information and communication technology in the industrial ecosystem.

NMEA 2000

NMEA 2000 is a protocol used to create a network of electronic devices – mainly marine instruments – on a boat. Various instruments that meet the NMEA 2000 standard are connected to one central cable, known as a backbone. The backbone powers each instrument and relays data among all the instruments on the network. This allows one display unit to show many different types of information and allows the instruments to work together. NMEA 2000 is meant to be "plug and play" to allow devices made by different manufacturers to talk and listen to each other.

Amphenol LTW's IPCS (Intelligent Pre-cabling Systems)

Amphenol LTW Intelligent Pre-Cabling System (IPCS) is your solution for the LED Lighting incorporation in indoor and outdoor applications. With a simplified design and wide flexibility, IPCS solves all your needs for electrical wiring and cabling infrastructure. It also provides large savings in on-site installation time and costs. The concept of IPCS is suitable for ALTW's various connector series, ideal for a large variety of customization.

Amphenol LTW's Power / Data / Hybrid Solutions

We are dedicated to developing interconnect solution to fulfill customer requirements of power or data applications, and as devices increasingly carry more functions in reduced spaces, Hybrid solutions are the answer to space limitation and multi-function. Below is the product series for Power, Data, and Hybrid applications.

0.5A ~ 2A

- Ceres
- X-Lok
- M Series
- D-Sub
- DVI
- HDMI
- USB
- HS-Lok
- FLOS & FLOS+

3A ~ 5A

- Ceres
- X-Lok
- M Series
- D-Sub
- SSL
- RBL
- HS-Lok
- FLOS & FLOS+
- NMEA 2000
- USB

6A ~ 10A

- Ceres
- X-Lok
- M Series
- Power
- Mini
- RBL
- FLOS & FLOS+
- NMEA 2000
- USB
- Cable Joiner & FICX

11A ~ 20A

- Ceres
- X-Lok
- M Series
- Power
- Mini
- RBL
- FLOS & FLOS+
- Cable Joiner & FICX

25A ~ 30A

- M Series
- FLOS & FLOS+
- Power

50A

- X-Lok
- Power

80A

- X-Lok
- Power

120A ~ 150A

- Power

Cross Section Conversion From AWG To mm²

26 AWG	0.14 mm ²	16 AWG	1.50 mm ²	4 AWG	25.00 mm ²
24 AWG	0.25 mm ²	14 AWG	2.50 mm ²	2 AWG	35.00 mm ²
22 AWG	0.34 mm ²	12 AWG	4.00 mm ²	1 AWG	50.00 mm ²
20 AWG	0.50 mm ²	10 AWG	6.00 mm ²	2/0 AWG	70.00 mm ²
18 AWG	0.75 mm ²	8 AWG	10.00 mm ²		
17 AWG	1.00 mm ²	6 AWG	16.00 mm ²		

Ingress Protection (IP) Rating Guide

Waterproof Definition

Unmated Waterproof



Standalone waterproof or waterproof is assured even without its counterpart. The water will not go through the inner portion of the exposed connector as it is entirely sealed.

Mated Waterproof



Waterproof is only assured when mated and locked tightly to its counterpart.

1st Digit - Solids

Degree of protection against solid objects

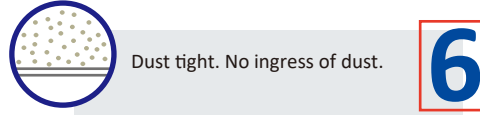
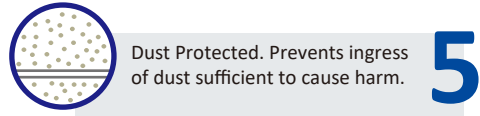
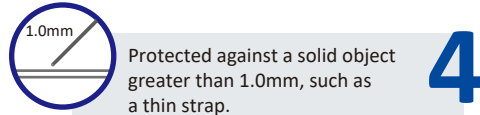
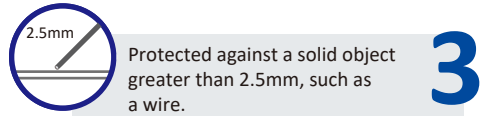
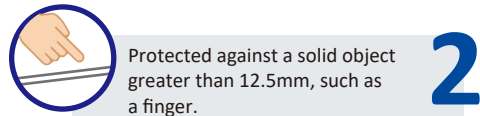
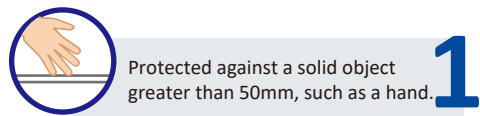
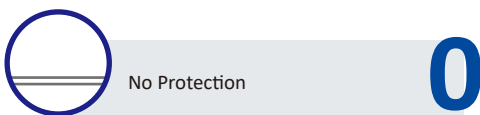

Example:



IP 65

Protected against water jets from any angle.

Dust tight. No ingress of dust.

2nd Digit - Liquids

Degree of protection against water

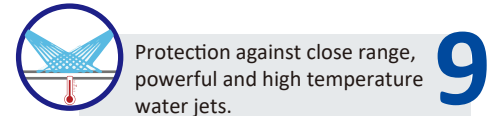
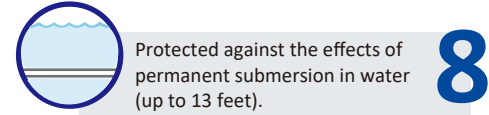
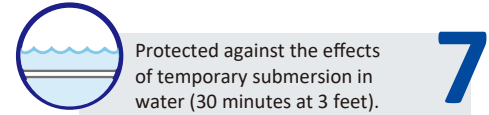
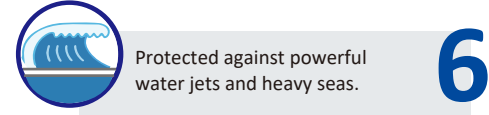
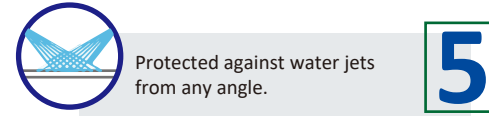
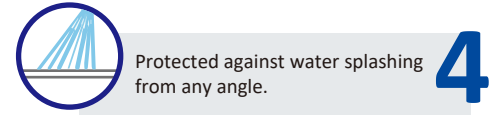
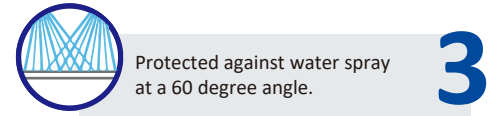
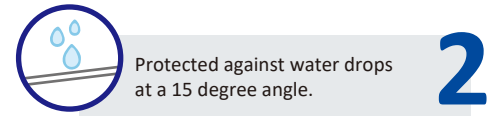
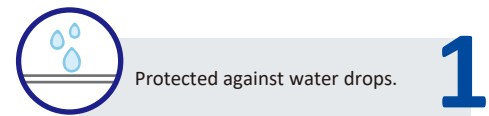

Amphenol LTW Technology Co., Ltd.

5F-3, No.51, Sec.4, Zhongyang Rd., Tucheng Dist., New Taipei City 236 Taiwan

Telephone : +886-2-7741-6888 Fax : +886-2-7741-6999

Email : sales@ltw-tech.com Web: amphenolltw.com

Kunshan Factory

No.62, DaTong Road, Development Zone, Kunshan City, JiangSu Province 215333 China

Telephone : +86-512-5761-0501 Fax : +86-512-5761-0515

For further information, please contact :

Luc Kan | Sales and Marketing

Email : luc@ltw-tech.com

