

THIS DOCUMENT IS SUBJECT TO CHANGE WITHOUT NOTICE. IT IS CONFIDENTIAL AND A PROPERTY OF Amphenol LTW. DISCLOSURE TO THIRD PARTY HAS TO BE AUTHORIZED BY Amphenol LTW.

REV.	ECN NO.	DATE	SIGN	DESCRIPTION
B	C201759 & 60	2020/11/17	Vicky	△B X5
C	C210231	2021/04/06	Vicky	△C X4

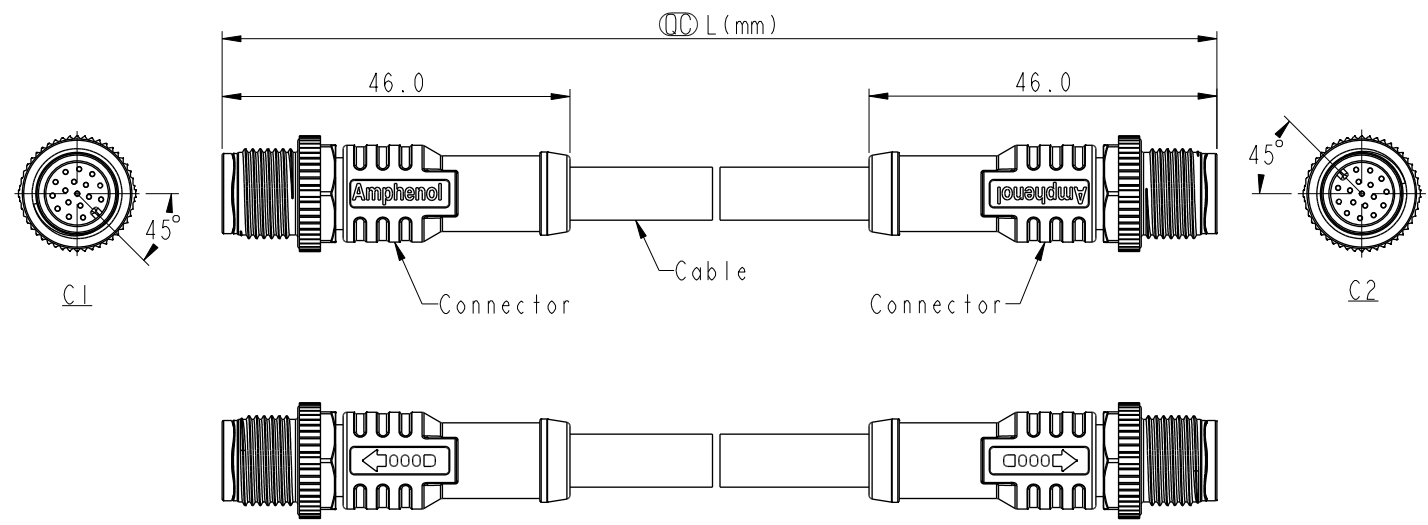

- Note:
- \* RoHS Compliant
  - \*  $\text{Ⓛ}$  Important dimension
  - \* Waterproof rate: IPX8, mated 1m/24h  
IPX9K, mated
  - \* Connector
    - Housing: Thermoplastic, Black
    - Pin: Copper alloy, Gold plated
    - Nut: Thermoplastic, Black
    - Outer Mold: Thermoplastic, Black
  - \* Cable: UL20549, PUR Jacket, Black
  - \* Cable Length Tolerance:
 



0.5M < L ≤ 1M	+60/-0 mm
1M < L ≤ 3M	+120/-0 mm
3M < L ≤ 5M	+160/-0 mm
5M < L ≤ 10M	±100 mm
10M < L ≤ 20M	±200 mm
20M < L ≤ 30M	±300 mm
30M < L ≤ 99M	±500 mm

UNIT: mm		TITLE	ACC, SEN, A Code, DB-ENDED						
TOLERANCE	±0.5mm	SCALE	1:2	SIZE	A4	SHEET	1	OF	2
		REV.	C	WC-REV.	A.5	$\text{Ⓛ}$	Inspection item		

**Amphenol LTW**  
安費諾亮泰企業股份有限公司



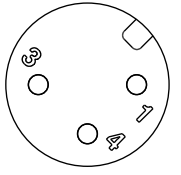
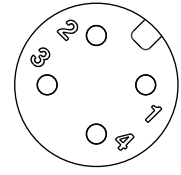
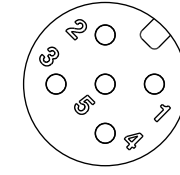
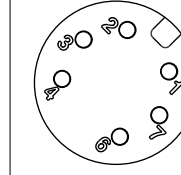
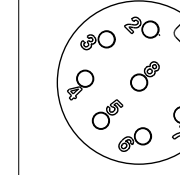
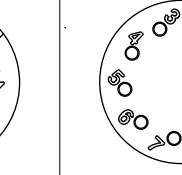
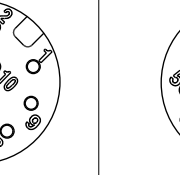
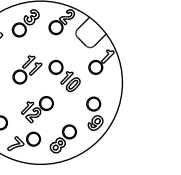

ITEM NO.	DRAWN BY	DATE
	Vicky	2018-12-05
DWG NO.	CHECKED BY	DATE
△BMSAPXXML-SAPML-SBXXX	Rita	2018-12-05
CUSTOMER	APPROVED BY	DATE
ALTW	Max	2018-12-05

1 2 3 4 5 6 7 8

F	 MSAPXXML - SAPML - SBXXX XX: No. Of Pin	XXX: 0.5~99Meters A05: 0.5 Meter 1: 01 Meter 2: 02 Meters : 99: 99 Meters		17P	7.0	26	MSAP17ML - SAPML - SBXXX	
				12P	6.0		MSAP12ML - SAPML - SBXXX	
10P	MSAP10ML - SAPML - SBXXX							
E				8P	4.8	24	MSAP08ML - SAPML - SBXXX	
				6P	5.0		MSAP06ML - SAPML - SBXXX	
				5P	4.4	22	MSAP05ML - SAPML - SBXXX	
				4P	4.0		MSAP04ML - SAPML - SBXXX	
				3P	3.8		MSAP03ML - SAPML - SBXXX	
					Contacts	Cable OD	AWG	Item No.

D	Pin Out	5 --	5 --	5 Gray	8 --	8 Red	12 --	12 Red/Blue	17 White/Gray	
		4 Black	4 Black	4 Black	7 Blue	7 Blue	11 --	11 Gray/Pink	16 Yellow/Brown	
C		3 Blue	3 Blue	3 Blue	6 Pink	6 Pink	10 Violet	10 Violet	15 White/Yellow	
		2 --	2 White	2 White	5 --	5 Gray	9 Black	9 Black	14 Brown/Green	
		1 Brown	1 Brown	1 Brown	4 Yellow	4 Yellow	8 Red	8 Red	13 White/Green	
		Pin #	Wire	Wire	Wire	Wire	Wire	Wire	Wire	Wire
		3 Blue	3 Blue	3 Blue	4 Green	4 Green	7 Blue	7 Blue	12 Red/Blue	
		2 --	2 White	2 White	3 Green	3 Green	6 Pink	6 Pink	11 Gray/Pink	
		1 Brown	1 Brown	1 Brown	2 Brown	2 Brown	5 Gray	5 Gray	10 Violet	
B	C1 & C2									
		3P	4P	5P	6P	8P	10P	12P	17P	

Pin Assignments Front View

A	UNIT:mm			TITLE	ACC, SEN, A Code, DB-ENDED		ITEM NO	DRAWN BY	Vicky	DATE	2018-12-05	
	TOLERANCE	±0.5mm		SCALE	1:2	SIZE	A4	SHEET	2	OF	2	
	REV.	C	WC-REV.	A.5	 Inspection item		<b>Amphenol LTW</b> 安費諾亮泰企業股份有限公司		CHECKED BY	Rita	DATE	2018-12-05
							CUSTOMER	ALTW	APPROVED BY	Max	DATE	2018-12-05