

THIS DOCUMENT IS SUBJECT TO CHANGE WITHOUT NOTICE. IT IS CONFIDENTIAL AND A PROPERTY OF Amphenol LTW. DISCLOSURE TO THIRD PARTY HAS TO BE AUTHORIZED BY Amphenol LTW.

REV.	ECN NO.	DATE	SIGN	DESCRIPTION
B	C201759 & 60	2020/11/17	Vicky	$\triangle B$ X5
C	C210231	2021/04/06	Vicky	$\triangle C$ X4

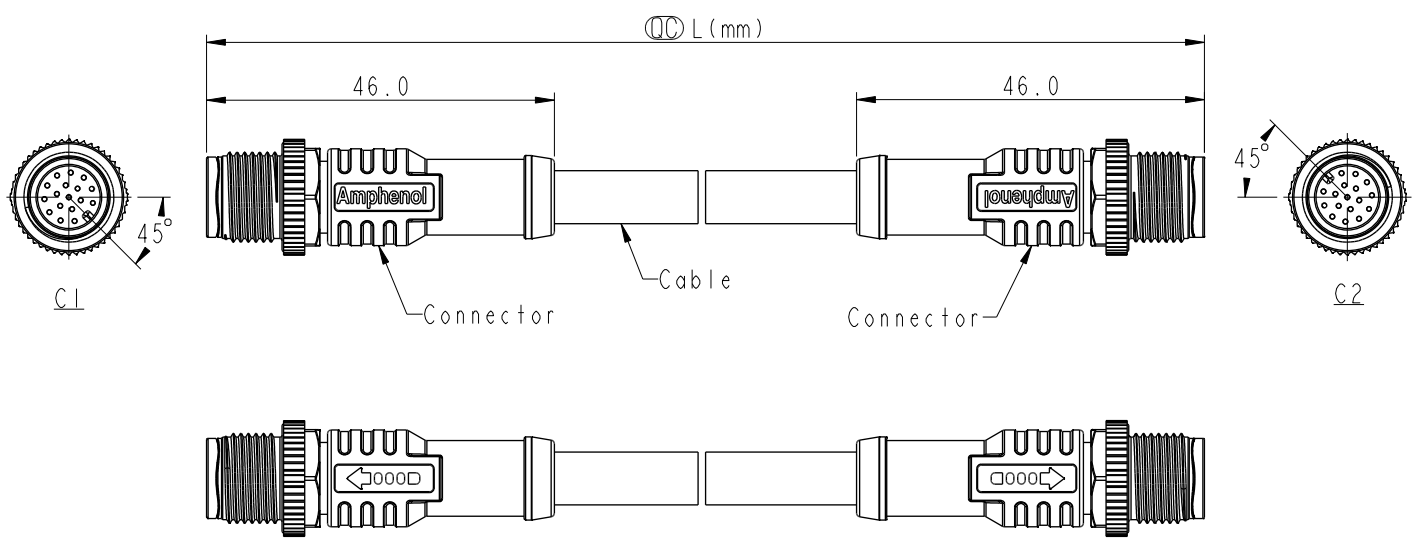

- $\triangle B \triangle C$
 Note:
- * RoHS Compliant
 - * \varnothing Important dimension
 - * Waterproof rate: IPX8, mated 1m/24h
IPX9K, mated
 - * Connector
 - Housing: Thermoplastic, Black
 - Pin: Copper alloy, Gold plated
 - Nut: Thermoplastic, Black
 - Outer Mold: Thermoplastic, Black
 - * Cable: UL2517, PVC Jacket, Black
 - * Cable Length Tolerance:

0.5M < L ≤ 1M	: +60/-0 mm
1M < L ≤ 3M	: +120/-0 mm
3M < L ≤ 5M	: +160/-0 mm
5M < L ≤ 10M	: ±100 mm
10M < L ≤ 20M	: ±200 mm
20M < L ≤ 30M	: ±300 mm
30M < L ≤ 99M	: ±500 mm



UNIT: mm		TITLE	ACC, SEN, A Code, DB-ENDED $\triangle C$
TOLERANCE	±0.5mm	SCALE	1:2
		SIZE	A4
		SHEET	1 OF 2
		WC-REV.	A.5
		\varnothing Inspection item	

Amphenol LTW
 安費諾亮泰企業股份有限公司

ITEM NO	DRAWN BY	DATE
	Vicky	2018-12-05
DWG NO	CHECKED BY	DATE
$\triangle B$ MSAPXXML-SAPML-SDXXX	Rita	2018-12-05
CUSTOMER	APPROVED BY	DATE
ALTW	Max	2018-12-05

THIS DOCUMENT IS SUBJECT TO CHANGE WITHOUT NOTICE. IT IS CONFIDENTIAL AND A PROPERTY OF Amphenol LTW. DISCLOSURE TO THIRD PARTY HAS TO BE AUTHORIZED BY Amphenol LTW.

1 2 3 4 5 6 7 8

F	 MSAPXXML - SAPML - SDXXX XX: No. Of Pin	XXX: 0.5~99Meters A05: 0.5 Meter 1: 01 Meter 2: 02 Meters : 99: 99 Meters		17P	7.0	26	MSAP17ML - SAPML - SDXXX				
				12P	6.0		MSAP12ML - SAPML - SDXXX				
10P		MSAP10ML - SAPML - SDXXX									
E				8P	5.5	24	MSAP08ML - SAPML - SDXXX				
				6P	5.0		MSAP06ML - SAPML - SDXXX				
				5P	5.1		MSAP05ML - SAPML - SDXXX				
								4P	4.8	22	MSAP04ML - SAPML - SDXXX
								3P	4.5		MSAP03ML - SAPML - SDXXX
								Contacts	Cable OD		AWG

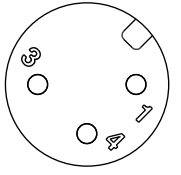
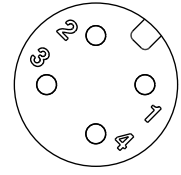
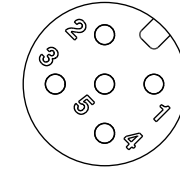
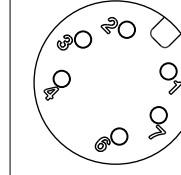
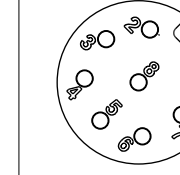
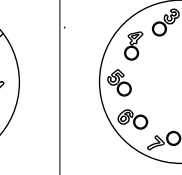
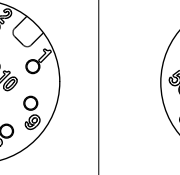
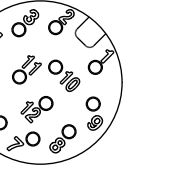
D	Pin Out	5 --	5 --	5 Gray	8 --	8 Red	12 --	12 Red/Blue	17 White/Gray	
		4 Black	4 Black	4 Black	7 Blue	7 Blue	11 --	11 Gray/Pink	16 Yellow/Brown	
C		3 Blue	3 Blue	3 Blue	6 Pink	6 Pink	10 Violet	10 Violet	15 White/Yellow	
		2 --	2 White	2 White	5 --	5 Gray	9 Black	9 Black	14 Brown/Green	
		1 Brown	1 Brown	1 Brown	4 Yellow	4 Yellow	8 Red	8 Red	13 White/Green	
					3 Green	3 Green	7 Blue	7 Blue	12 Red/Blue	
					2 Brown	2 Brown	6 Pink	6 Pink	11 Gray/Pink	10 Violet
					1 White	1 White	5 Gray	5 Gray	9 Red	9 Red
							4 Yellow	4 Yellow	8 Gray	8 Gray
B	C1 & C2	3P	4P	5P	6P	8P	10P	12P	17P	
										

Pin Assignments Front View

A	UNIT:mm		TITLE	ACC, SEN, A Code, DB-ENDED	 Amphenol LTW 安費諾亮泰企業股份有限公司	ITEM NO		DRAWN BY	Vicky	DATE	2018-12-05		
	TOLERANCE	±0.5mm	SCALE	1:2		SIZE	A4	SHEET	2 OF 2	CHECKED BY	Rita	DATE	2018-12-05
	REV.	C	WC-REV.	A.5		QC	Inspection item	CUSTOMER	ALTW	APPROVED BY	Max	DATE	2018-12-05

1 2 3 4 5 6 7 8 W10814-03-0001A2