

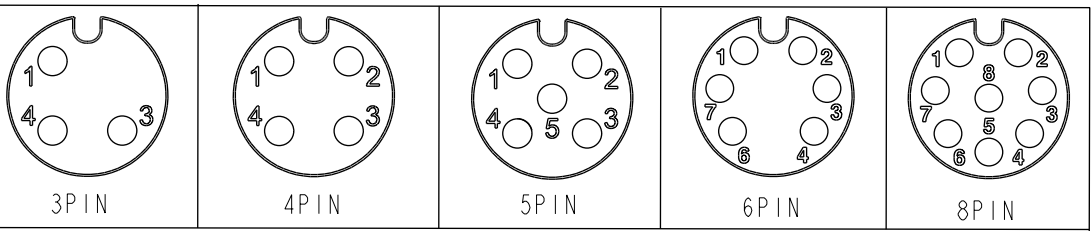

THIS DOCUMENT IS SUBJECT TO CHANGE WITHOUT NOTICE. IT IS CONFIDENTIAL AND A PROPERTY OF Amphenol LTW. DISCLOSURE TO THIRD PARTY HAS TO BE AUTHORIZED BY Amphenol LTW.

REV.	ECN NO.	DATE	SIGN	DESCRIPTION
A	C210370	2021/03/10	Carl Dong	
B	C210561	2021/04/15	Vicky	 XI

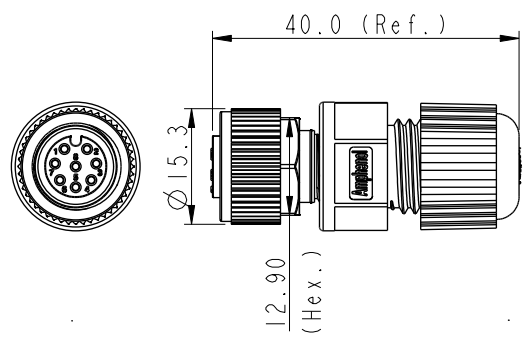
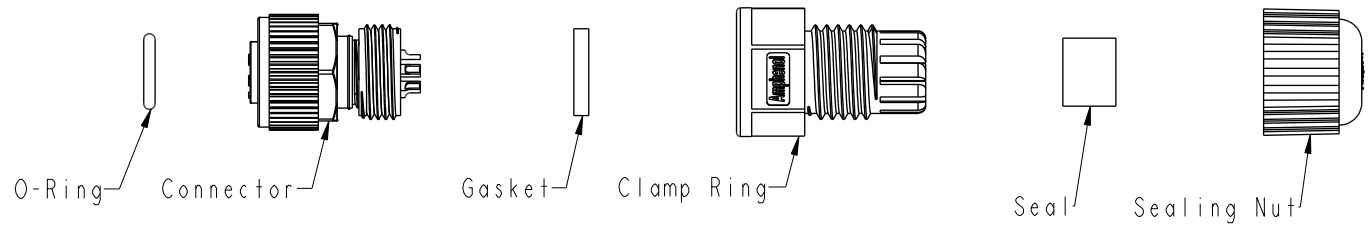

Pin Assignments Front View

- Note:
- *  Important Dimension To Check
 - * Waterproof Rate: IP68
 - * Housing: Nylon+GF, Black, UL746C fl
 - * Pin: Copper Alloy, Gold Plated
 - * Nut: Nylon, Black
 - * Gasket: Silicone, Gray
 - * Clamp Ring: Nylon, Black
 - * Sealing Nut: Nylon, Black
 - * Seal: Silicone, Dark Gray
 - * Seal For Cable OD: $\varnothing 4.5\text{mm} \sim \varnothing 6.5\text{mm}$
 - * O-Ring: Silicone, Gray
 -  * One set unassembled in one pe bag

UNIT: mm		
TOLERANCE	± 0.5	

TITLE M12 A CODE Assy F Conn F PIN			
SCALE 1:1	SIZE A4	SHEET 1 OF 2	
REV. B	WC-REV. .0	 : Inspection item	

Amphenol LTW
安費諾亮泰企業股份有限公司

ITEM NO.	DRAWN BY Carl Dong	DATE 2021-03-10
DWG NO. MSAP-XXBFFA-SL8001-1	CHECKED BY Fisher Wang	DATE 2021-03-10
CUSTOMER 10000164	APPROVED BY Max Yang	DATE 2021-03-10

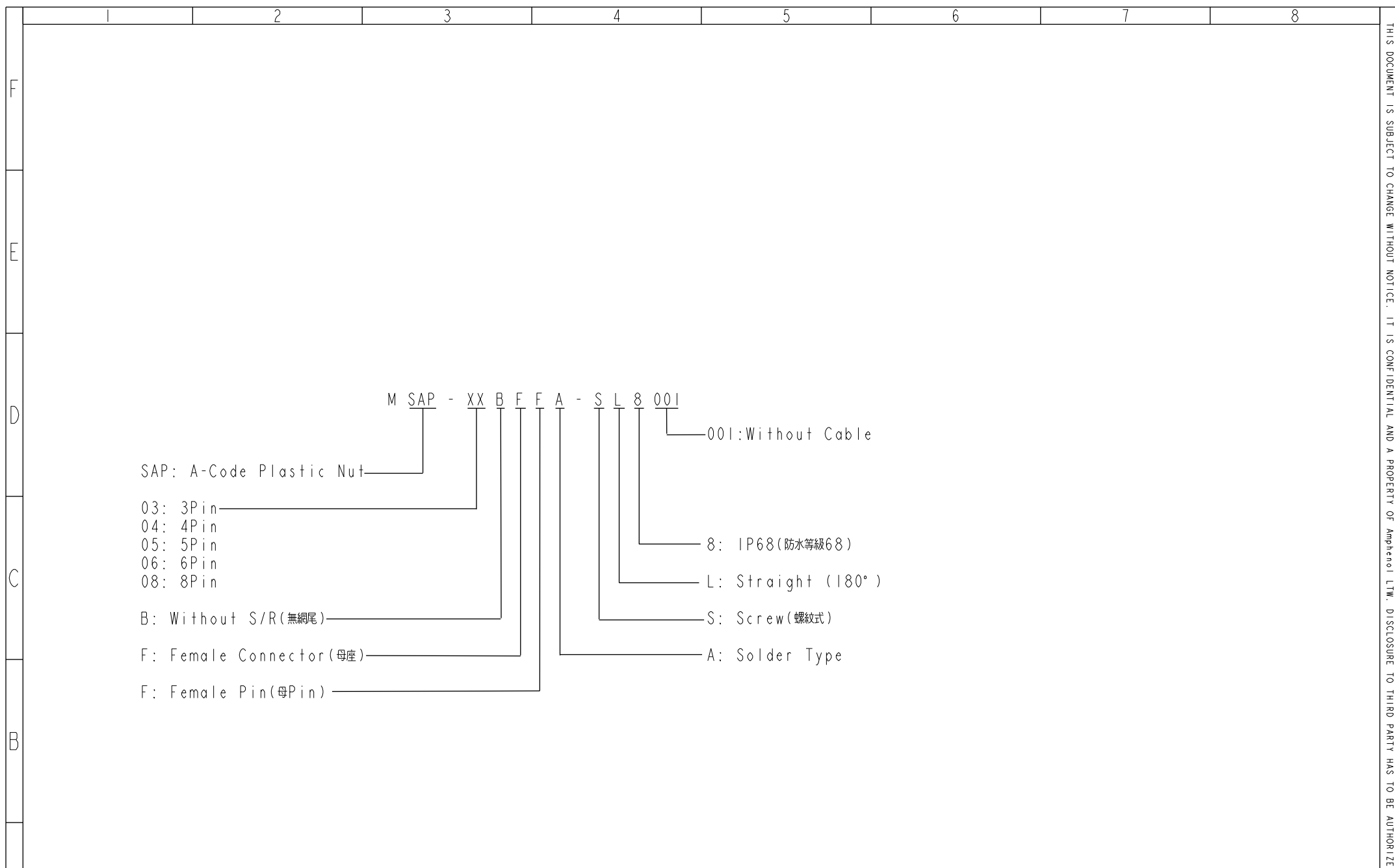

M SAP - XX B F F A - S L 8 001
 001: Without Cable

SAP: A-Code Plastic Nut

- 03: 3Pin
- 04: 4Pin
- 05: 5Pin
- 06: 6Pin
- 08: 8Pin

B: Without S/R(無網尾)

F: Female Connector(母座)

F: Female Pin(母Pin)

8: IP68(防水等級68)

L: Straight (180°)

S: Screw(螺紋式)

A: Solder Type

A	UNIT:mm		TITLE M12 A CODE Assy F Conn F PIN		Amphenol LTW 安費諾亮泰企業股份有限公司	ITEM NO	DRAWN BY Carl Dong	DATE 2021-03-10	
	TOLERANCE ± 0.5		SCALE 1:1	SIZE A4		SHEET 2 OF 2	DWG NO MSAP-XXBFFA-SL8001-1	CHECKED BY Fisher Wang	DATE 2021-03-10
	REV. B	WC-REV. .0	②: Inspection item			CUSTOMER 10000164	APPROVED BY Max Yang	DATE 2021-03-10	