

THIS DOCUMENT IS SUBJECT TO CHANGE WITHOUT NOTICE. IT IS CONFIDENTIAL AND A PROPERTY OF AMPHENOL LTW. DISCLOSURE TO THIRD PARTY HAS TO BE AUTHORIZED BY AMPHENOL LTW.

REV.	ECN NO.	DATE	SIGN	DESCRIPTION
F	C201481	2020/09/22	Vicky	△F X4
G	C210020	2021/01/07	Vicky	△G X1
H	C210221	2021/03/18	Vicky	△H X4

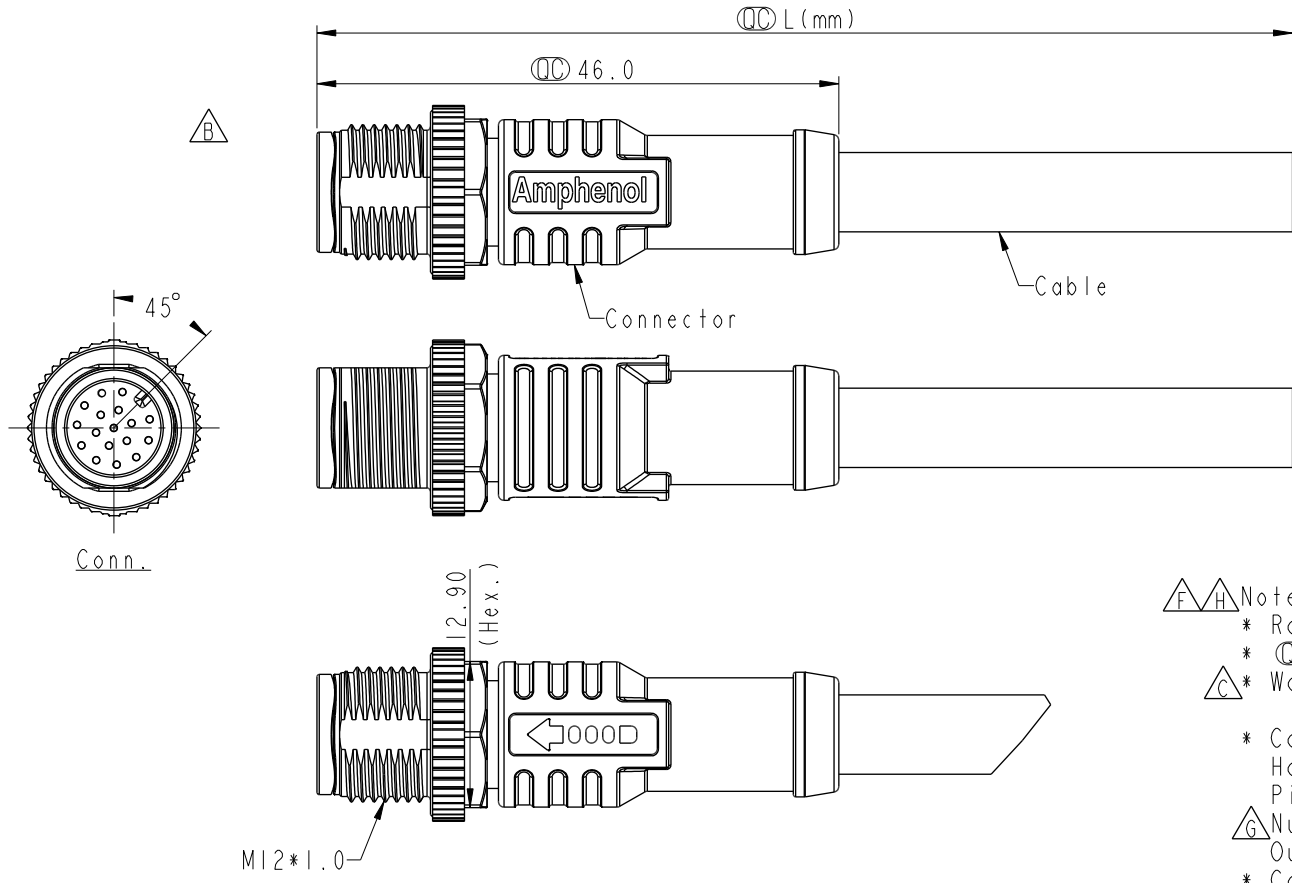

- Note:**
- * RoHS Compliant
 - * \varnothing Important dimension
 - * Waterproof rate: IPX8, mated 1m/24h
IPX9K, mated
 - * Connector
 - Housing: Thermoplastic, Black
 - Pin: Copper alloy, Gold plated
 - * Nut: Metal
 - Outer mold: Thermoplastic, Black
 - * Cable: UL2517, PVC Jacket, Yellow
 - * Cable length tolerance:

1M < L ≤ 3M	+50/-0 mm
3M < L ≤ 5M	+150/-0 mm
5M < L ≤ 10M	±100 mm
10M < L ≤ 20M	±200 mm
20M < L ≤ 30M	±300 mm
30M < L ≤ 99M	±500 mm

UNIT: mm		TITLE	
TOLERANCE	±0.5mm	N SEN, M12 A, SCREW CABLE W/O SR, M, M, MOLDING	
SCALE	3:2	SIZE	A4
REV.	H	SHEET	1 OF 2
WC-REV.	A.3	\varnothing : Inspection item	

Amphenol LTW
安費諾亮泰企業股份有限公司

ITEM NO.	DRAWN BY	DATE
	Lingpeng	2017-04-06
DWG NO.	CHECKED BY	DATE
△M12A-XXBMMM-SL8AXX	Ma Fei	2017-04-06
CUSTOMER	APPROVED BY	DATE
ALTW	Jerry	2017-04-06

THIS DOCUMENT IS SUBJECT TO CHANGE WITHOUT NOTICE. IT IS CONFIDENTIAL AND A PROPERTY OF Amphenol LTW. DISCLOSURE TO THIRD PARTY HAS TO BE AUTHORIZED BY Amphenol LTW.

 M12A-XXBMMM-SL8AXX XX: No. Of Pin							 17P 7.0 12P 6.0 10P 6.0 8P 5.5 6P 5.0 5P 5.1 4P 4.8 3P 4.5  5P 5.1 4P 4.8 3P 4.5  Contacts Cable OD AWG Item No.
							26 24 22
							M12A-17BMMM-SL8AXX M12A-12BMMM-SL8AXX M12A-10BMMM-SL8AXX M12A-08BMMM-SL8AXX M12A-06BMMM-SL8AXX M12A-05BMMM-SL8AXX M12A-04BMMM-SL8AXX M12A-03BMMM-SL8AXX
							XX:01~99Meters 01:01Meter 02:02Meters : 99:99Meters

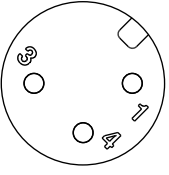
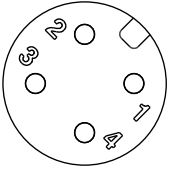
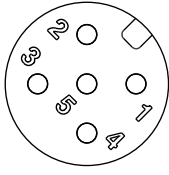
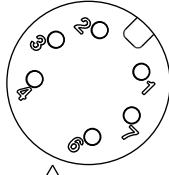
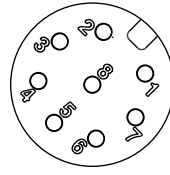
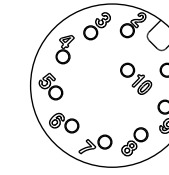
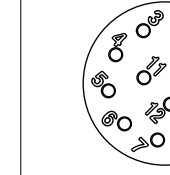
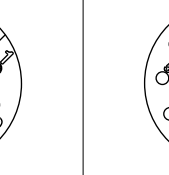
	Pin Out	Pin # Wire	Pin # Wire	Pin # Wire	Pin # Wire	Pin # Wire	Pin # Wire	Pin # Wire	Pin # Wire
C		5 -- Black 黑 4 Blue 藍 3 Blue 藍 2 -- 1 Brown 棕	5 -- Black 黑 4 Black 黑 3 Blue 藍 2 White 白 1 Brown 棕	5 Gray 灰 4 Black 黑 3 Blue 藍 2 White 白 1 Brown 棕	8 -- 7 Blue 藍 6 Pink 粉 5 -- 4 Yellow 黃 3 Green 綠 2 Brown 棕 1 White 白	8 Red 紅 7 Blue 藍 6 Pink 粉 5 Gray 灰 4 Yellow 黃 3 Green 綠 2 Brown 棕 1 White 白	12 -- 11 -- 10 Violet 紫 9 Black 黑 8 Red 紅 7 Blue 藍 6 Pink 粉 5 Gray 灰 4 Yellow 黃 3 Green 綠 2 Brown 棕 1 White 白	12 Red/Blue 紅/藍 11 Gray/Pink 灰/粉 10 Violet 紫 9 Black 黑 8 Red 紅 7 Blue 藍 6 Pink 粉 5 Gray 灰 4 Yellow 黃 3 Green 綠 2 Brown 棕 1 White 白	17 White/Gray 白/灰 16 Yellow/Brown 黃/棕 15 White/Yellow 白/黃 14 Brown/Green 棕/綠 13 White/Green 白/綠 12 Red/Blue 紅/藍 11 Gray/Pink 灰/粉 10 Violet 紫 9 Red 紅 8 Gray 灰 7 Black 黑 6 Yellow 黃 5 Pink 粉 4 Green 綠 3 White 白 2 Blue 藍 1 Brown 棕
B	Conn.								

Pin Assignments Front View

UNIT:mm			TITLE N SEN, M12 A, SCREW CABLE W/O SR, M, M, MOLDING		ITEM NO	DRAWN BY Lingpeng	DATE 2017-04-06	
TOLERANCE	±0.5mm		SCALE 3:2	SIZE A4	SHEET 2 OF 2	DWG NO M12A-XXBMMM-SL8AXX	CHECKED BY Ma Fei	DATE 2017-04-06
REV. H	WC-REV. A.3	QC: Inspection item		Amphenol LTW 安費諾亮泰企業股份有限公司		CUSTOMER ALTW	APPROVED BY Jerry	DATE 2017-04-06