

THIS DOCUMENT IS SUBJECT TO CHANGE WITHOUT NOTICE. IT IS CONFIDENTIAL AND A PROPERTY OF Amphenol LTW. DISCLOSURE TO THIRD PARTY HAS TO BE AUTHORIZED BY Amphenol LTW.

REV.	ECN NO.	DATE	SIGN	DESCRIPTION
D	BOMR20070098	2020/07/20	Peng	$\triangle D$ X5
E	C201447	2020/09/18	Ruru	$\triangle E$ X6
F	C210309	2021/02/23	Ruru	$\triangle F$ X3

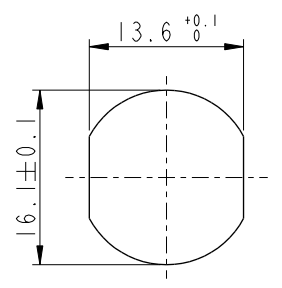

$\triangle B \triangle E$

$\triangle C \triangle D \triangle E$

M12A-XXPFFP-SF8002

XX: No. Of Pin

Recommended Panel Cut-Out

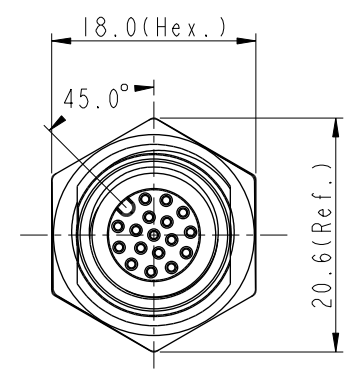
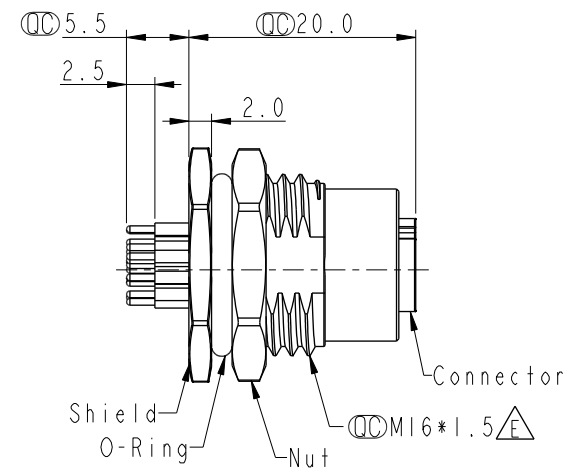
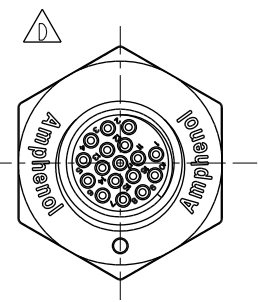

- $\triangle F \triangle E$ Note:
- * RoHS Compliant
 - * CC Important dimension
 - * $\triangle C$ Waterproof rate: IPX8, unmated 1m/24h IPX9K, unmated
 - * Connector
 - Housing: Thermoplastic, Black
 - Pin: Copper alloy, Gold plated
 - O-Ring: Rubber, Green
 - * Shield: Metal
 - * Nut: Metal
 - * O-Ring: Rubber, Black
 - * For panel thickness max: 4.5mm
 - * Nut is packed separately in pe bag

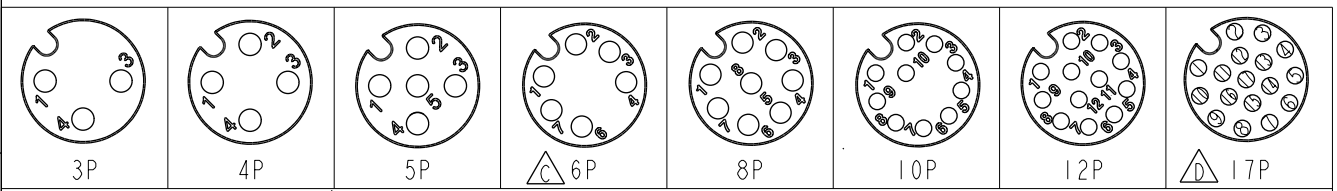





Pin Assignment Front View

UNIT: mm			TITLE N SEN, M12 A, SCREW RECEPTACLE, F, F, PCB S $\triangle E$
TOLERANCE .X ±0.25 .XX ±0.1 .XXX ±0.05 ANGLES ±1°	SCALE 2:1	SIZE A4	SHEET 1 OF 2
	REV. F	WC-REV. A.5	CC : Inspection item

Amphenol LTW
安費諾亮泰企業股份有限公司

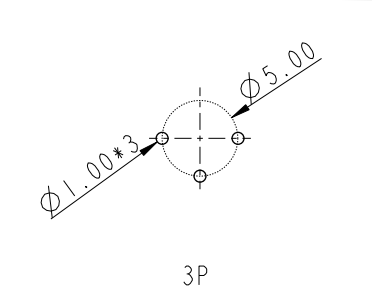
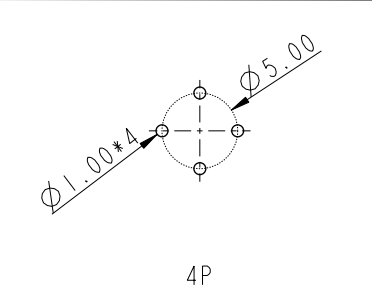
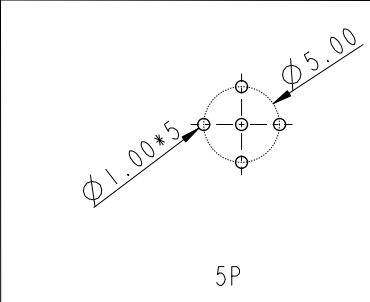
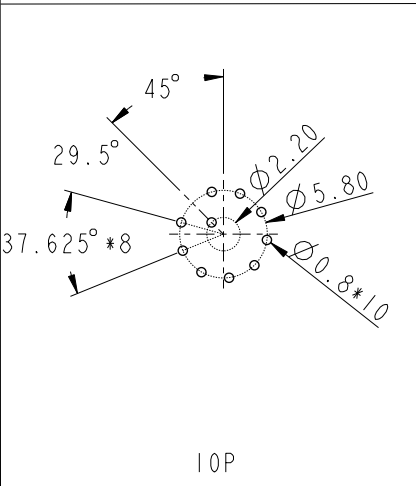
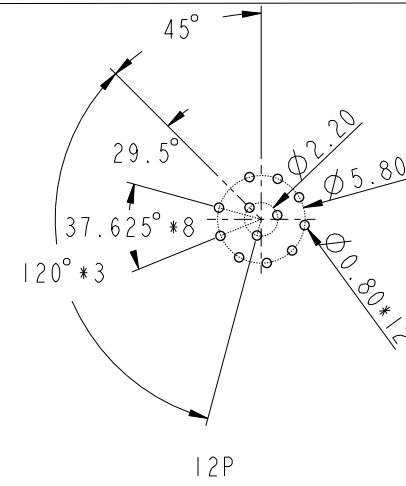
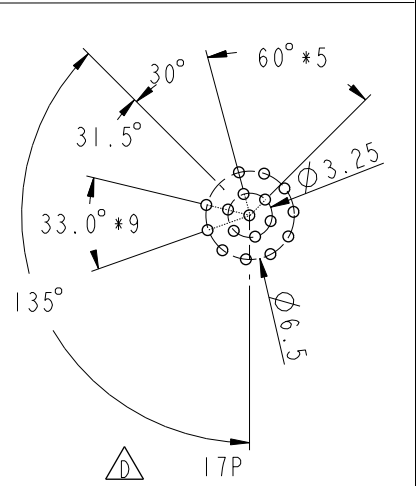
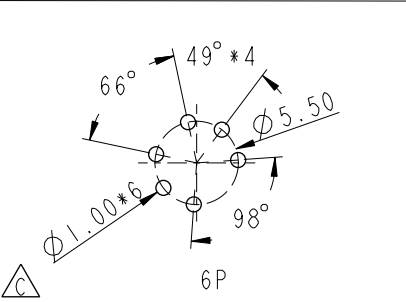
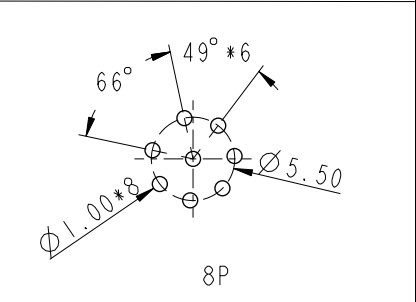
ITEM NO	DRAWN BY Yulong_wang	DATE 2016-08-08
DWG NO $\triangle E$ M12A-XXPFFP-SF8002	CHECKED BY Jinhai	DATE 2016-08-08
CUSTOMER ALTW	APPROVED BY Jerry	DATE 2016-08-08

THIS DOCUMENT IS SUBJECT TO CHANGE WITHOUT NOTICE. IT IS CONFIDENTIAL AND A PROPERTY OF Amphenol LTW. DISCLOSURE TO THIRD PARTY HAS TO BE AUTHORIZED BY Amphenol LTW.

F									
E									
D	PCB Layout								
C	 <p style="text-align: center;">3P</p>	 <p style="text-align: center;">4P</p>	 <p style="text-align: center;">5P</p>	 <p style="text-align: center;">10P</p>	 <p style="text-align: center;">12P</p>	 <p style="text-align: center;">17P</p>	 <p style="text-align: center;">6P</p>	 <p style="text-align: center;">8P</p>	
B									
A	UNIT: mm  	TITLE N SEN, M12 A, SCREW RECEPTACLE, F, F, PCB S 			<h1 style="margin: 0;">Amphenol LTW</h1> <h2 style="margin: 0;">安費諾亮泰企業股份有限公司</h2>		ITEM NO M12A-XXPFFP-SF8002	DRAWN BY Yulong_wang	DATE 2016-08-08
	TOLERANCE .X ±0.25 .XX ±0.1 .XXX ±0.05 ANGLES ±1°	SCALE 2:1	SIZE A4	SHEET 2 OF 2	REV. F	WC-REV. A.4	CUSTOMER ALTW	CHECKED BY Jinhai	DATE 2016-08-08
			(CC): Inspection item				APPROVED BY Jerry	DATE 2016-08-08	W10814-03-01A2