

REV.	ECN NO.	DATE	SIGN	DESCRIPTION
B	LEN-0C0299	2010/11/25	Ivan Lin	Change View & Frame
C	LEN14B0091	2014/11/03	Vicky	Update Logo

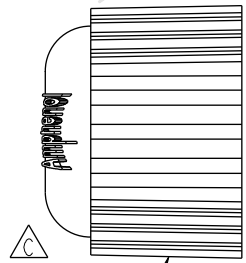

Sealing Nut 5

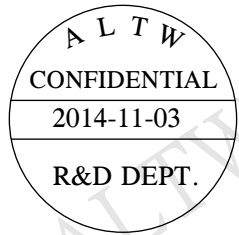
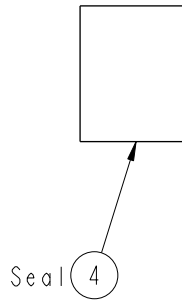

Seal 4

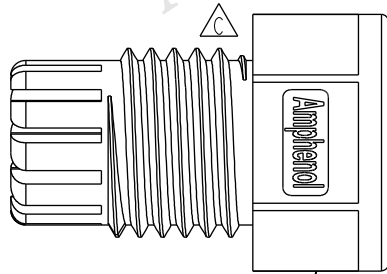

Clamp Ring 3

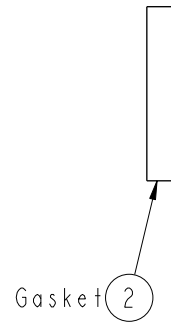

Gasket 2

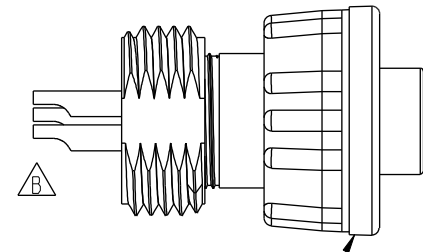

Connector 1

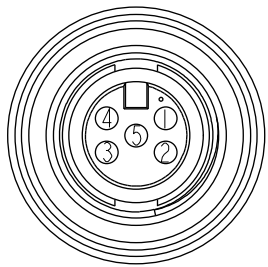

Pin Assignments
Front View

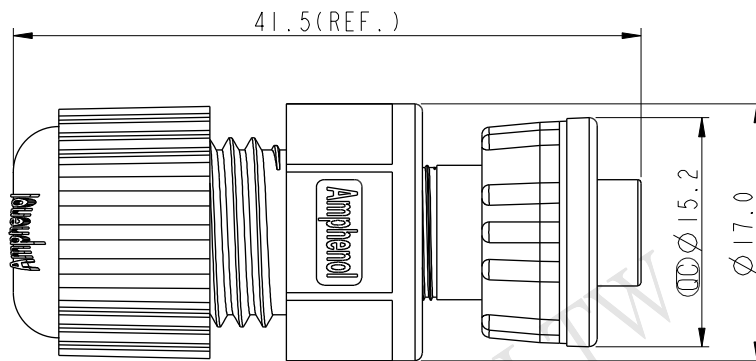

Note:

- * CC Important Dimension To Check.
- * Waterproof Rate: IP67
- * Housing: Nylon+GF, Black
- * Female Pin: Copper Alloy, Gold Plated
- * O-Ring: EPDM, Black
- * Screw Nut: Nylon+GF, Black
- * B Gasket: EPDM, Black
- * Clamp Ring: Nylon, Black
- * Seal: EPDM, Black
- * Sealing Nut: Nylon, Black
- * Seal For Cable OD: O 4.5mm~ O 6.5mm
(防水墊圈線徑: O 4.5mm~ O 6.5mm)
- * One Set Unassembled In One PE Bag
(每一組未組裝, 放置於一個PE袋, 並封口)

UNIT:mm

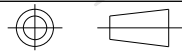

TOLERANCE
.X ± 0.25
.XX ± 0.1
.XXX ± 0.05
ANGLES $\pm 1^\circ$

TITLE Mini Assy Screw 5Pin F Conn F Pin			
SCALE 2:1	SIZE A4	SHEET 1 OF 1	
REV. C	WC-REV. A.1	CC : Inspection item	

Amphenol LTW
安費諾亮泰企業股份有限公司

ITEM NO AU-05BFFA-SL7001	DRAWN BY Vicky	DATE 2014-11-03
DWG NO AU-05BFFA-SL7001	CHECKED BY Sam	DATE 2014-11-03
CUSTOMER ALTW	APPROVED BY Rita	DATE 2014-11-03

THIS DOCUMENT IS SUBJECT TO CHANGE WITHOUT NOTICE. IT IS CONFIDENTIAL AND A PROPERTY OF Amphenol LTW. DISCLOSURE TO THIRD PARTY HAS TO BE AUTHORIZED BY Amphenol LTW.