

THIS DOCUMENT IS SUBJECT TO CHANGE WITHOUT NOTICE. IT IS CONFIDENTIAL AND A PROPERTY OF Amphenol LTW. DISCLOSURE TO THIRD PARTY HAS TO BE AUTHORIZED BY Amphenol LTW.

REV.	ECN NO.	DATE	SIGN	DESCRIPTION
A	Initial Release	2018/10/18	Mafei	Change Rev.01 To Rev.A

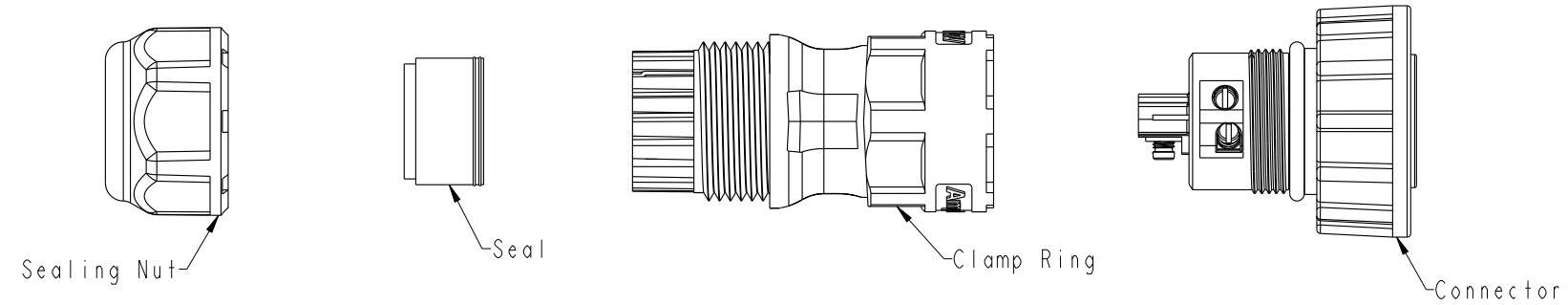

Material Specification:

- * Connector: Thermoplastic
- * Terminal: Copper Alloy, Silver Plated.
- * Gasket & O-Ring: Rubber.
- * UL Rated: UL 94V-0, fl.
- * RoHS Compliant.

Electrical Specification:

- * Contact Resistance: 10mΩ Max.
- * Insulation Resistance: 100MΩ Min.
- * Dielectric Withstand Voltage: 1,600 Vac.

Mechanical Specification:

- * Durability: 1000 Cycles.
- * Wire conductor: 14#~12#(2.0mm²~3.3mm²).
- * Wire insulation OD: Max 4.0mm.
- * Torque Force for Clamp Ring: 6~8 kgf-cm
- * Torque Force for Seal Nut: 8~15 kgf-cm
- * Torque Force for Screw: 4~5 kgf-cm

Environmental Specification:

- * Waterproof Rating: IP67(Mated, 1M/30 Minutes)
- * Temperature Range: -40°C to 105°C.
- * Salt Spray: Mated, 500 Hours.
- * Safety Compliance: UL 1977.

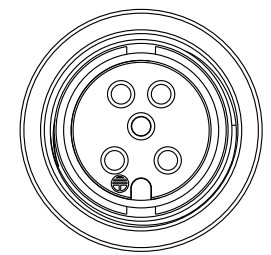
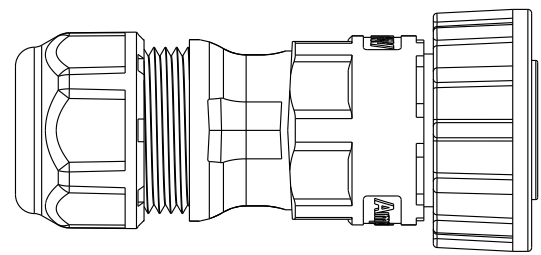
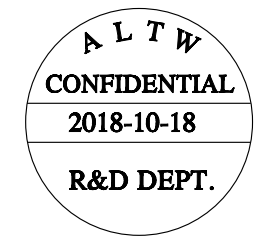
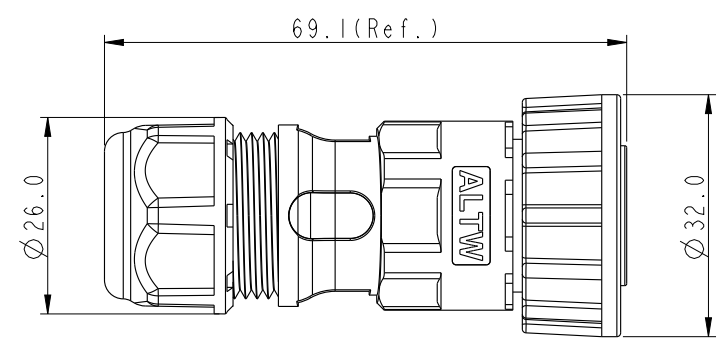



UNIT:mm			TITLE Circular D-Size Field Installable Cable Screw-In Type F Conn F Pin		
TOLERANCE ±0.5 mm			SCALE 8:5	SIZE A4	SHEET 1 OF 2
REV. A	WC-REV. A.3	QC: Inspection item			

Amphenol LTW
安費諾亮泰企業股份有限公司

ITEM NO.	DRAWN BY Mafei	DATE 2018-10-18
DWG NO. IDC-XXBFFB-SL7XPP	CHECKED BY Jerry	DATE 2018-10-18
CUSTOMER ALTW	APPROVED BY Max	DATE 2018-10-18

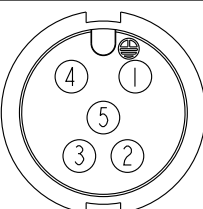
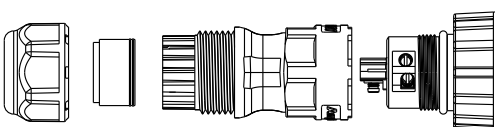
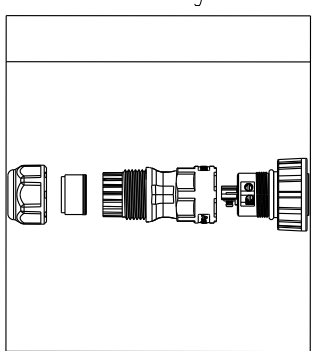
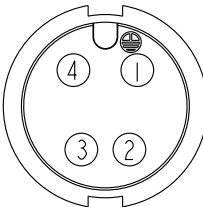
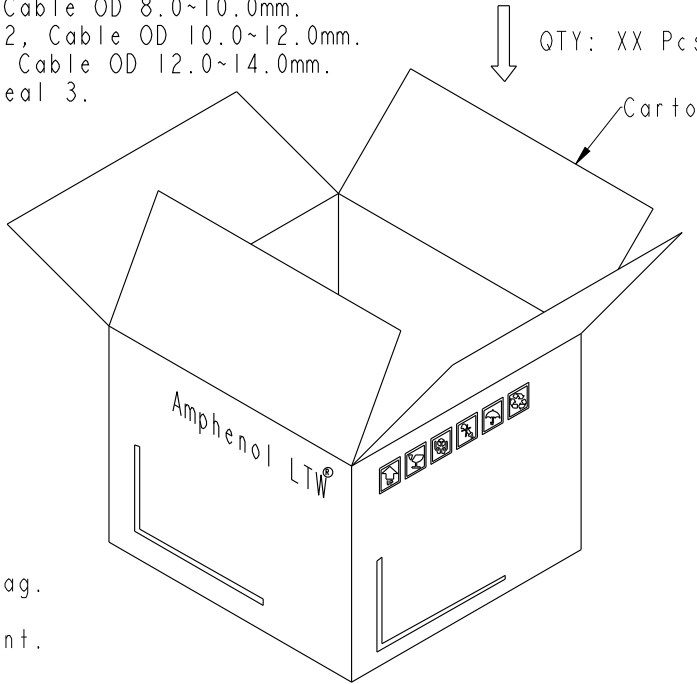
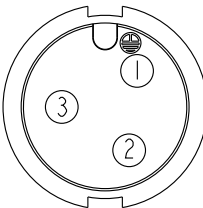
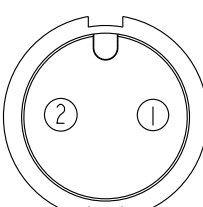
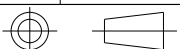
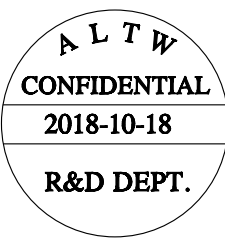
THIS DOCUMENT IS SUBJECT TO CHANGE WITHOUT NOTICE. IT IS CONFIDENTIAL AND A PROPERTY OF Amphenol LTW. DISCLOSURE TO THIRD PARTY HAS TO BE AUTHORIZED BY Amphenol LTW.

F												
E			20A ; 300Vac/Vdc 5 Contacts(05)				QTY: 1 Pcs					
D			20A ; 300Vac/Vdc 4 Contacts(04)	Ordering Information: IDC- XX BFFB-SL7XPP								
C			20A ; 300Vac/Vdc 3 Contacts(03)	Number of Contacts						S: With Red Color Seal 1, Cable OD 8.0~10.0mm. M: With Yellow Color Seal 2, Cable OD 10.0~12.0mm. L: With Blue Color Seal 3, Cable OD 12.0~14.0mm. A: With Seal 1 & Seal 2 & Seal 3.		
B			20A ; 300Vac/Vdc 2 Contacts(02)	02 03 04 05								
A	UNIT:mm 					Note: * One Set Unassembled In One PE Bag. (每一組未組裝, 放置於一個PE袋, 並封口, 如圖示) * Label is Attached To PE Bag Front. (標籤貼在PE袋正面)						
TOLERANCE ±0.5 mm		TITLE Circular D-Size Field Installable Cable Screw-In Type F Conn F Pin			SCALE 8:5 SIZE A4 SHEET 2 OF 2			REV. A WC-REV. A.3  : Inspection item				
<h1 style="margin: 0;">Amphenol LTW</h1> <h2 style="margin: 0;">安費諾亮泰企業股份有限公司</h2>				ITEM NO DWG NO CUSTOMER		DRAWN BY CHECKED BY APPROVED BY		DATE DATE DATE				
				ALTW		Mafei Jerry Max		2018-10-18 2018-10-18 2018-10-18				
1	2	3	4	5	6	7	8	8	FMW10702-01-02A1			