

THIS DOCUMENT IS SUBJECT TO CHANGE WITHOUT NOTICE. IT IS CONFIDENTIAL AND A PROPERTY OF Amphenol LTW. DISCLOSURE TO THIRD PARTY HAS TO BE AUTHORIZED BY Amphenol LTW.

REV.	ECN NO.	DATE	SIGN	DESCRIPTION
B	E191899	2019/11/19	Ruru	$\triangle B$ X4

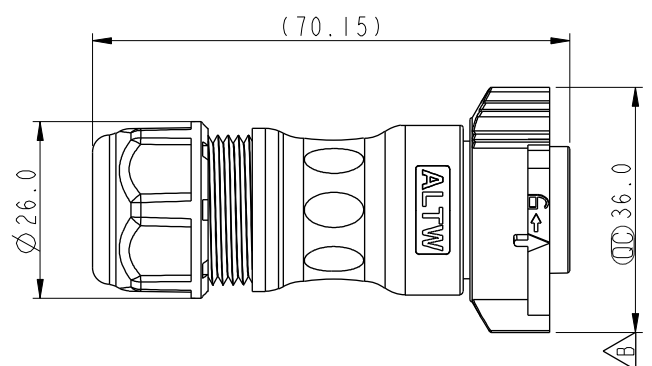
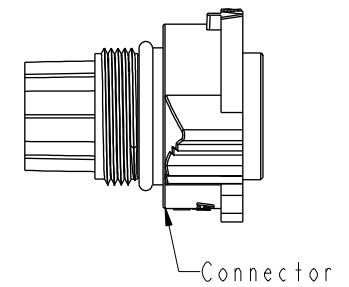
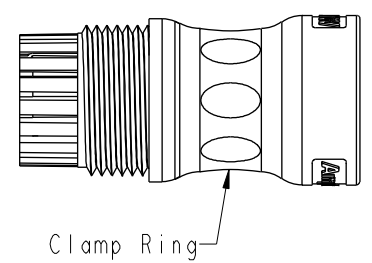
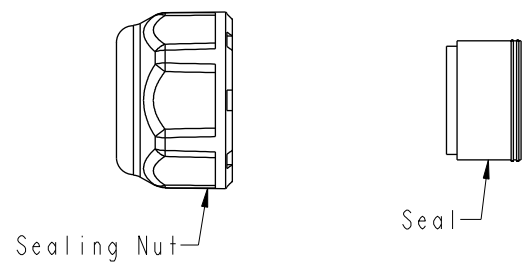

DC-XXBFMA-QL8XNP

02-2 Pin
03-3 Pin
05-5 Pin

S: With Red Color Seal 1, Cable OD 6.0~8.0mm.
M: With Yellow Color Seal 2, Cable OD 8.0~10.0mm.
L: With Blue Color Seal 3, Cable OD 10.0~12.0mm.
A: With Seal 1 & Seal 2 & Seal 3.

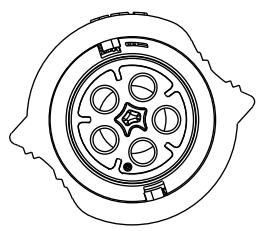
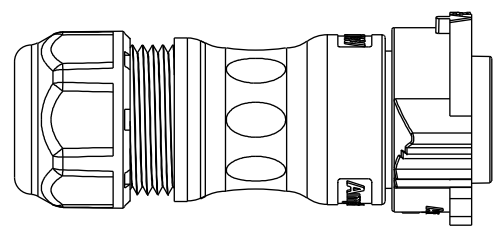

- $\triangle B$ Note:
- * ϕ Important Dimension
 - * Waterproof Rate: IP68, Mated
IP68 : 1M Depth Of Water In 24hours
 - * Housing: Thermoplastic, Black
 - * Clamp Ring: Thermoplastic, Black
 - * Sealing Nut: Thermoplastic, Black
 - * Seals: Rubber

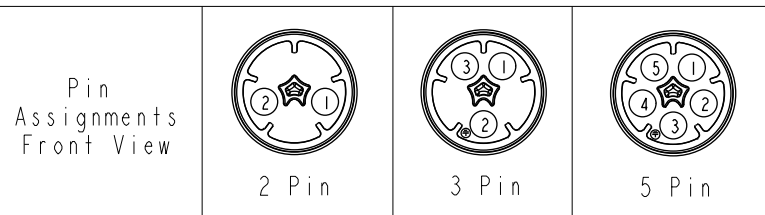

UNIT:mm TOLERANCE ± 0.5 mm	TITLE XLOK, D-20A, CABLE W/O SR F, M, FI CRIMP, XLOK $\triangle B$		Amphenol LTW 安費諾亮泰企業股份有限公司		ITEM NO	DRAWN BY Ruru	DATE 2019-11-19
	SCALE 1:1	SIZE A4			SHEET 1	OF 1	DWG NO DC-XXBFMA-QL8XNP $\triangle B$
	REV. B	WC-REV. .0	ϕ : Inspection item		CUSTOMER ALTW	APPROVED BY Max	DATE 2019-11-19