

THIS DOCUMENT IS SUBJECT TO CHANGE WITHOUT NOTICE. IT IS CONFIDENTIAL AND A PROPERTY OF Amphenol LTW. DISCLOSURE TO THIRD PARTY HAS TO BE AUTHORIZED BY Amphenol LTW.

REV.	ECN NO.	DATE	SIGN	DESCRIPTION
A		2020/01/13	Ruru	Initial Released

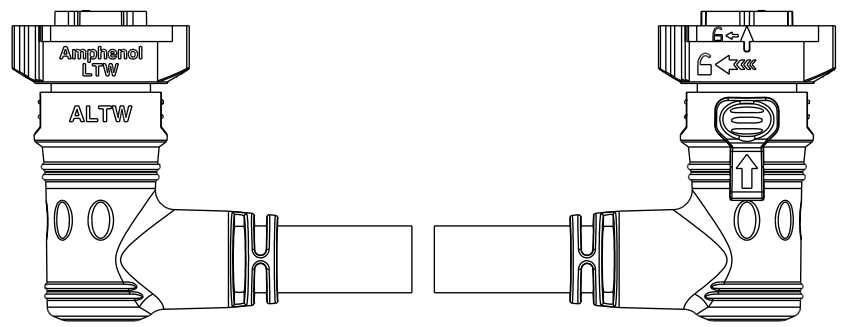
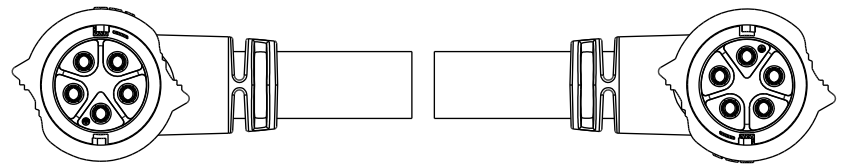
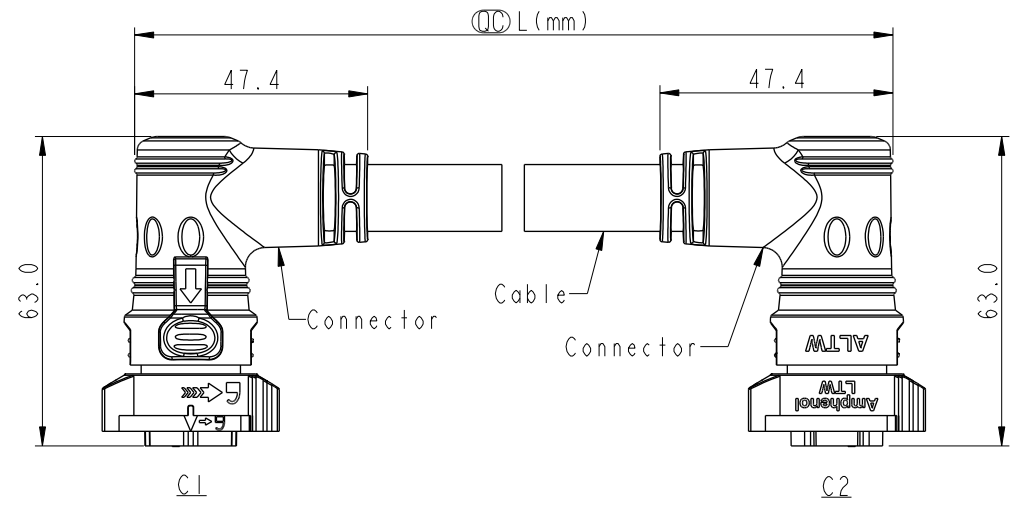

- Note:
- \*  $\varnothing$  Important Dimension.
  - \* Waterproof Rate: IP68, Mated.  
IP68: 1M depth of water in 24 hours.
  - \* Connector: Thermoplastic, Black.
  - \* Pin: Copper Alloy, Gold Plated.
  - \* Cable: SJTW, PVC Jacket, Black.
  - \* Cable Length Tolerance:
    - 0.5M: +60/-0mm
    - 01M: +60/-0mm
    - 02~03M: +120/-0mm
    - 04~05M: +160/-0mm
    - 06~10M: ±100mm
    - 11~20M: ±200mm
    - 21~30M: ±300mm
    - 31~99M: ±500mm

UNIT: mm		
TOLERANCE	±0.5 mm	

TITLE ACC, XLOK, D-20A, DB-ENDED FF		
SCALE 1:2	SIZE A4	SHEET 1 OF 2
REV. A	WC-REV.	$\varnothing$ : Inspection item

**Amphenol LTW**  
安費諾亮泰企業股份有限公司

ITEM NO.	DRAWN BY Ruru	DATE 2020-01-13
DWG NO. AB-DCXXFR-DCFR-QEXXX	CHECKED BY Rita	DATE 2020-01-13
CUSTOMER ALTW	APPROVED BY Max	DATE 2020-01-13

THIS DOCUMENT IS SUBJECT TO CHANGE WITHOUT NOTICE. IT IS CONFIDENTIAL AND A PROPERTY OF Amphenol LTW. DISCLOSURE TO THIRD PARTY HAS TO BE AUTHORIZED BY Amphenol LTW.

5P		PVC	13.6	12	AB-DC05FR-DCFR-QEXXX
3P			11.7		AB-DC03FR-DCFR-QEXXX
2P			10.7		AB-DC02FR-DCFR-QEXXX
Contacts	Cable Jacket	Cable OD	AWG	Item No.	

AB- DC XX FR - DC FR - Q E XXX

02: 2Pin  
03: 3Pin  
05: 5Pin

XXX: 0.5~99Meters  
A05: 0.5 Meter  
001: 01 Meter  
002: 02 Meters  
:  
099: 99 Meters

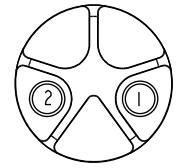
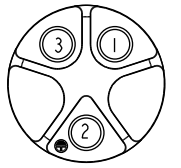
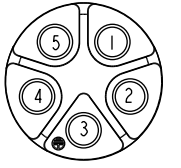
Pin Out	2 White 白 1 Black 黑	3 Green 綠 2 White 白 1 Black 黑	5 Brown 棕 4 Red 紅 3 Green 綠 2 White 白 1 Black 黑
	Pin # Wire	Pin # Wire	Pin # Wire
C1 & C2			
	2P	3P	5P
Pin Assignments Front View			

UNIT:mm 

TOLERANCE  
± 0.5 mm

TITLE ACC, XLOK, D-20A, DB-ENDED  
FF

SCALE 1:2 SIZE A4 SHEET 2 OF 2

REV. A WC-REV. :Inspection item

**Amphenol LTW**  
安費諾亮泰企業股份有限公司

ITEM NO	DRAWN BY Ruru	DATE 2020-01-13
DWG NO AB-DCXXFR-DCFR-QEXXX	CHECKED BY Rita	DATE 2020-01-13
CUSTOMER ALTW	APPROVED BY Max	DATE 2020-01-13