

**ALTW**  
**CONFIDENTIAL**  
 2016-11-21  
**R&D DEPT.**

REV.	ECN NO.	DATE	SIGN	DESCRIPTION
C	LEN1690193~96	2016/09/23	Mafei	Change The Wire Color.
D	LEN16B0212~15	2016/11/21	Mafei	Adding The Housing Key Point.

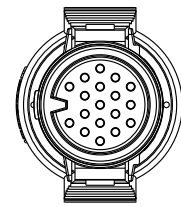
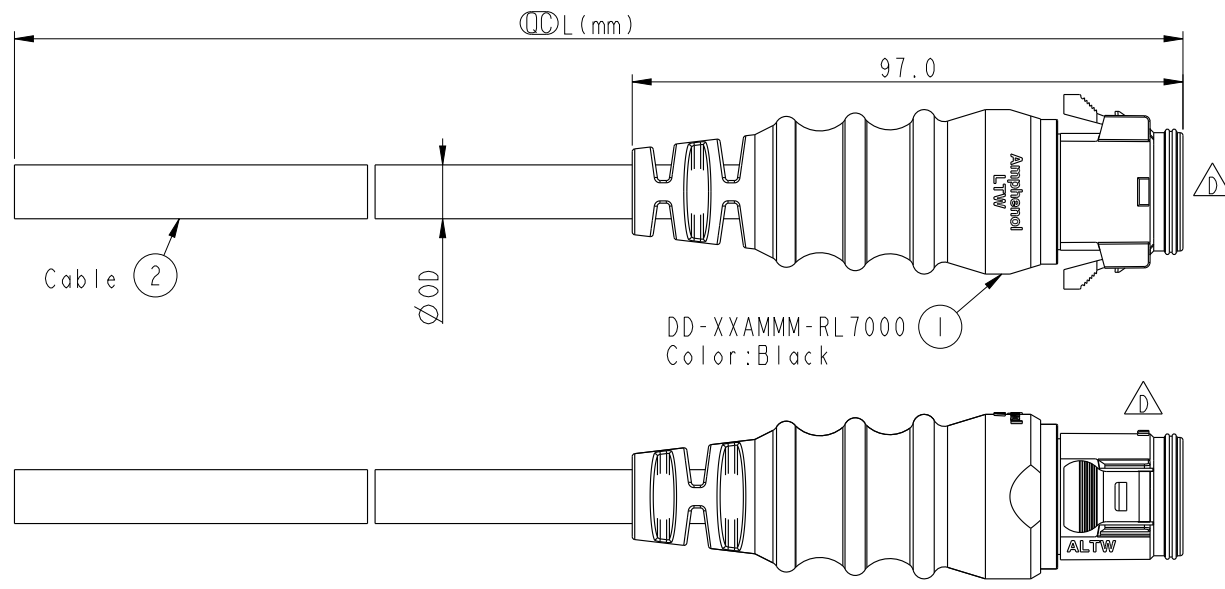

**ALTW**  
 DCC. DEPT.  
 CONFIDENTIAL  
 2016.11.28  
 ISSUED

DD-XXAMMM-RL7A XX

Large Size Current Rating 5A

XX: No. Of Pin (Pin 數)

A: Cable With S/R (線端帶網尾)

M: Male Connector (公座)

M: Male Pin (公Pin)

M: Molding Type (射出成型)

XX: 01~99 Meter  
 01: 01 Meter  
 02: 02 Meter  
 ...  
 99: 99 Meter

A: UL 2464 Cable  
 7: IP67 (防水等級 67)  
 L: Straight (180°)  
 R: Snap In With Latch (彈臂卡合)

Note:

- \*  $\varnothing$  Important Dimension
- \* Waterproof Rate: IP67
- \* Housing: M-PPE, Black
- \* Male Pin: Copper Alloy, Gold Plated
- \* Cable: UL2464 20#, PVC Jacket, Black.
- \* Cable Length Tolerance: 01M: ±40mm  
 02M~05M: ±60mm  
 06M~10M: ±100mm  
 11M~30M: ±200mm  
 31M~99M: ±500mm
- \* Prohibiting the use of place in oils

DD-10AMMM-RL7AXX	∅ 9.0
DD-12AMMM-RL7AXX	
DD-14AMMM-RL7AXX	
DD-18AMMM-RL7AXX	∅ 9.5
Part No.	Cable OD



UNIT: mm		TITLE
TOLERANCE	±0.5	LARGE CABLE RBL M CONN M PIN
SCALE	3:4	SIZE A4
REV.	D	SHEET 1 OF 2
WC-REV.	A.9	$\varnothing$ : Inspection item

**Amphenol LTW**  
 安費諾亮泰企業股份有限公司

ITEM NO.	DRAWN BY	DATE
	Mafei	2016-11-21
DWG NO.	CHECKED BY	DATE
DD-XXAMMM-RL7AXX	Youdan	2016-11-21
CUSTOMER	APPROVED BY	DATE
ALTW	Jerry	2016-11-21

THIS DOCUMENT IS SUBJECT TO CHANGE WITHOUT NOTICE. IT IS CONFIDENTIAL AND A PROPERTY OF Amphenol LTW. DISCLOSURE TO THIRD PARTY HAS TO BE AUTHORIZED BY Amphenol LTW.

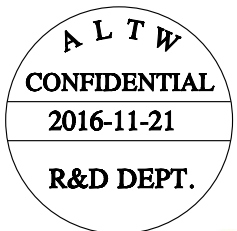
THIS DOCUMENT IS SUBJECT TO CHANGE WITHOUT NOTICE. IT IS CONFIDENTIAL AND A PROPERTY OF AMPHENOL LTW. DISCLOSURE TO THIRD PARTY HAS TO BE AUTHORIZED BY AMPHENOL LTW.

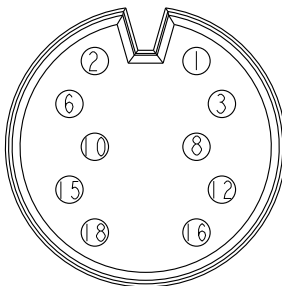
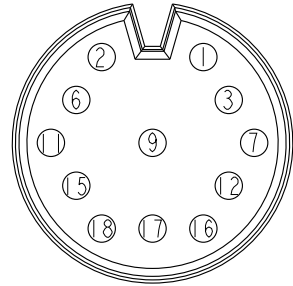
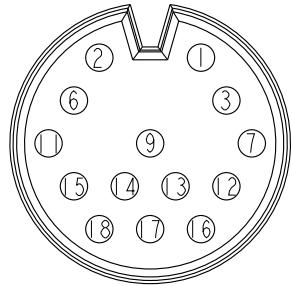
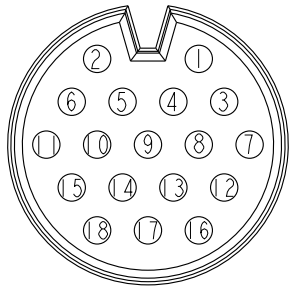
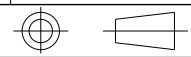
△B									
	△C								
Pin Out	18 Purple(紫) 17 -- 16 Brown(棕) 15 Orange(橘) 14 -- 13 -- 12 Yellow(黃) 11 -- 10 Gray(灰) 9 -- 8 Red(紅) 7 -- 6 Green(綠) 5 -- 4 -- 3 Blue(藍) 2 White(白) 1 Black(黑)	18 Black/White(黑/白) 17 Orange(橘) 16 Pink(粉紅) 15 Gray(灰) 14 -- 13 -- 12 Purple(紫) 11 Yellow(黃) 10 -- 9 Green(綠) 8 -- 7 White(白) 6 Brown(棕) 5 -- 4 -- 3 Blue(藍) 2 Black(黑) 1 Red(紅)	18 Black/White(黑/白) 17 Brown/White(棕/白) 16 Light Green(淺綠) 15 Pink(粉紅) 14 Purple(紫) 13 Brown(棕) 12 Orange(橘) 11 Yellow(黃) 10 -- 9 Gray(灰) 8 -- 7 Red(紅) 6 Green(綠) 5 -- 4 -- 3 Blue(藍) 2 White(白) 1 Black(黑)	18 Light Green(淺綠) 17 Green/White(綠/白) 16 Orange/White(橘/白) 15 Brown/White(棕/白) 14 Blue/White(藍/白) 13 Black/White(黑/白) 12 Red/White(紅/白) 11 Orange(橘) 10 Pink(粉紅) 9 Gray(灰) 8 Purple(紫) 7 Yellow(黃) 6 Green(綠) 5 White(白) 4 Brown(棕) 3 Blue(藍) 2 Black(黑) 1 Red(紅)					
Pin Assignments Front View	 10Pin	 12Pin	 14Pin	 18Pin					
UNIT:mm	 TOLERANCE ±0.5		TITLE <b>LARGE CABLE RBL M CONN M PIN</b>		<b>Amphenol LTW</b> 安費諾亮泰企業股份有限公司		ITEM NO DD-XXAMMM-RL7AXX	DRAWN BY Mafei	DATE 2016-11-21
			SCALE 3:4	SIZE A4	SHEET 2 OF 2			CHECKED BY Youdan	DATE 2016-11-21
			REV. D	WC-REV. A.9	QC: Inspection item	CUSTOMER ALTW	APPROVED BY Jerry	DATE 2016-11-21	
									8 FMW10702-01-02A1