

THIS DOCUMENT IS SUBJECT TO CHANGE WITHOUT NOTICE. IT IS CONFIDENTIAL AND A PROPERTY OF Amphenol LTW. DISCLOSURE TO THIRD PARTY HAS TO BE AUTHORIZED BY Amphenol LTW.

REV.	ECN NO.	DATE	SIGN	DESCRIPTION
A	Initial Release	2020-10-22	Yuwei Chou	Change Rev.01 To Rev.A

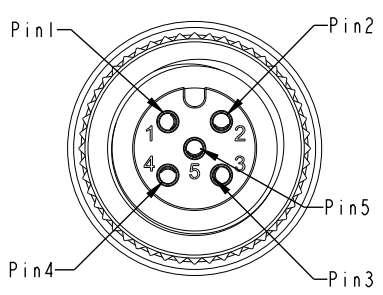
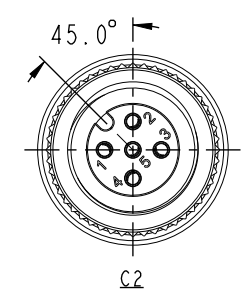
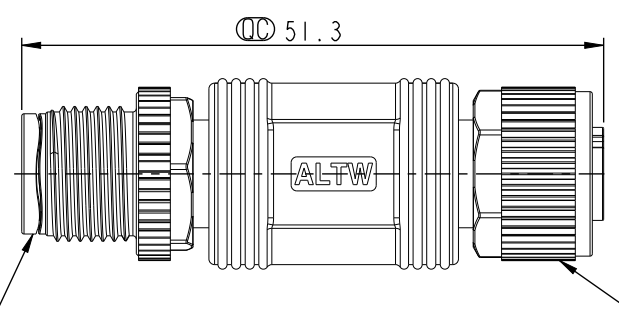
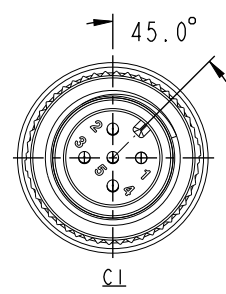
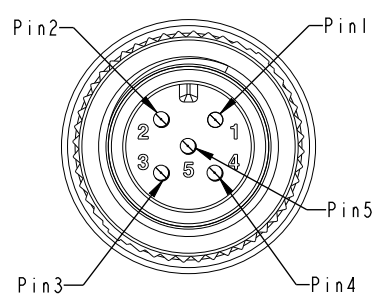
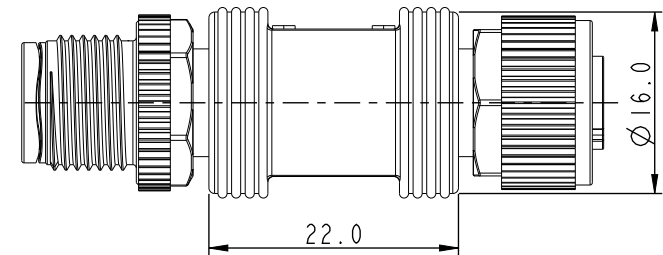
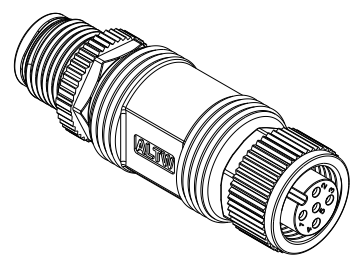

5	Blue 藍 (22AWG)	5
4	White 白 (22AWG)	4
3	Black 黑 (22AWG)	3
2	NC	2
1	Green 綠 (22AWG)	1
C1	Wire Color	C2

Pin Out

Note:
 * \varnothing Important Dimension.
 * Waterproof Rate: IP68(Mated, 1M/24 Hours)
 * Connector: Black, PU
 * Pins: Copper Alloy, Gold Plated
 * Screw Nut: Nylon + G/F, Black.
 * Wire Harness: UL1007/TR64 22AWG, OD=0.76mm

UNIT: mm	
TOLERANCE	±0.5 mm

TITLE NMEA2000 MICRO-C 1-ADAPTOR			
SCALE 3:2	SIZE A4	SHEET 1 OF 1	
REV. A	WC-REV. A.4	\varnothing : Inspection item	

Amphenol LTW
 安費諾亮泰企業股份有限公司

ITEM NO. HPC-000505-0MF-IS002	DRAWN BY Yuwei Chou	DATE 2020-10-22
DWG NO. HPC-000505-0MF-IS002	CHECKED BY Arvin Chan	DATE 2020-10-22
CUSTOMER ALTW	APPROVED BY Max Yang	DATE 2020-10-22