

THIS DOCUMENT IS SUBJECT TO CHANGE WITHOUT NOTICE. IT IS CONFIDENTIAL AND A PROPERTY OF Amphenol LTW. DISCLOSURE TO THIRD PARTY HAS TO BE AUTHORIZED BY Amphenol LTW.

REV.	ECN NO.	DATE	SIGN	DESCRIPTION
C	LE313C0106	2013-12-16	Fisher	Change Plating and Package
D	CI91496	2019-08-29	NianPing Yu	Add UL Label
E	CI92063	2019-12-03	NianPing Yu	△E.XI

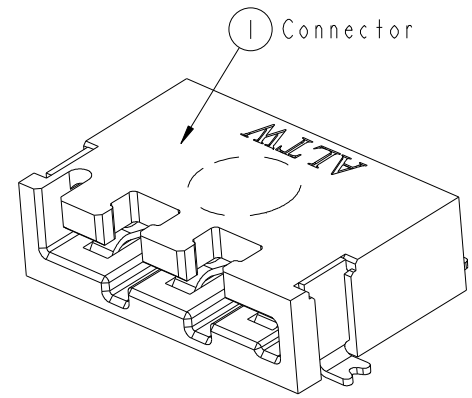

RECOMMENDED P.C.B. LAYOUT
GENERAL TOLERANCE IS ±0.05

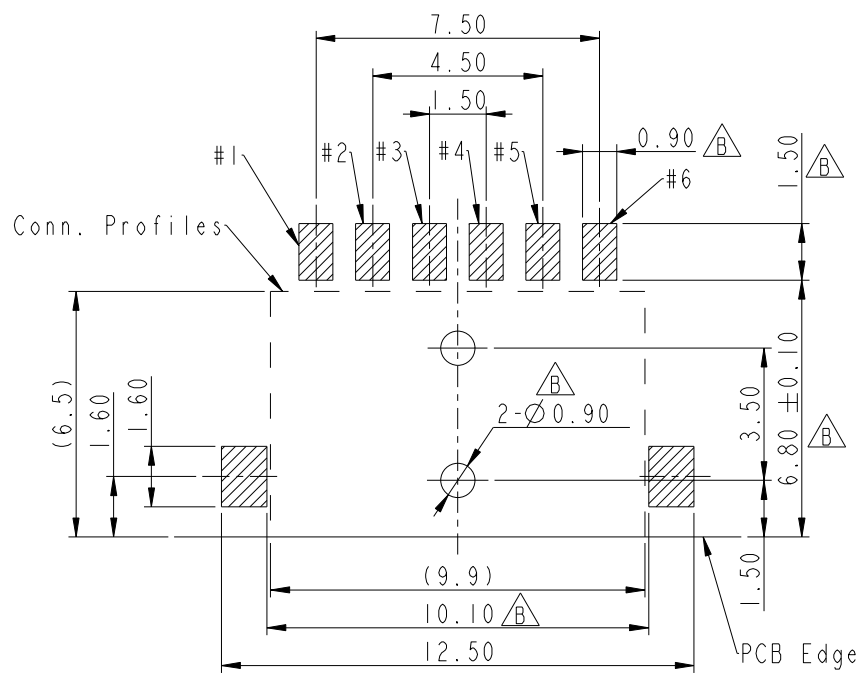
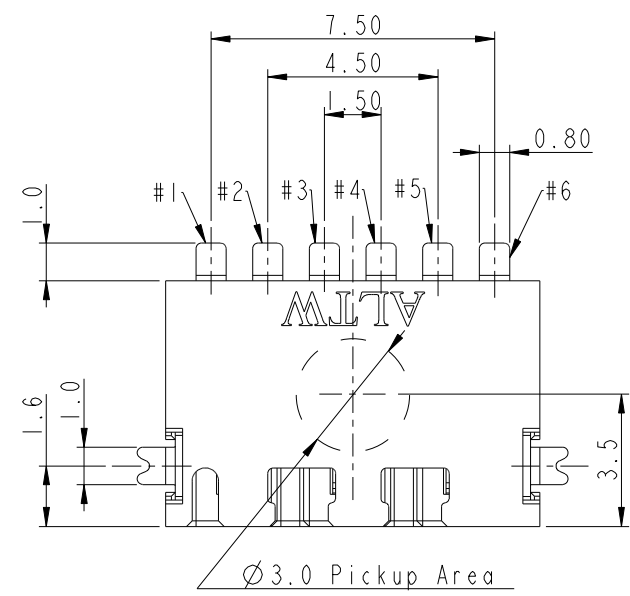
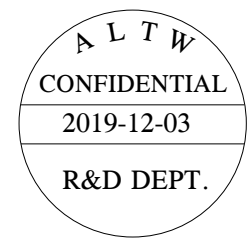
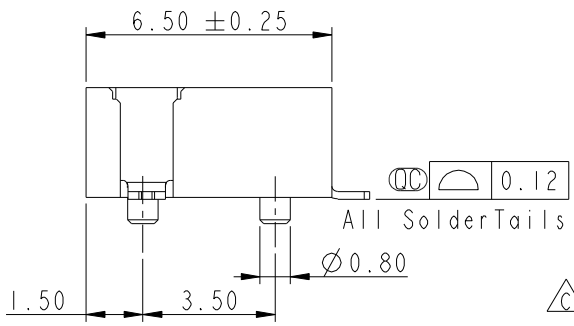
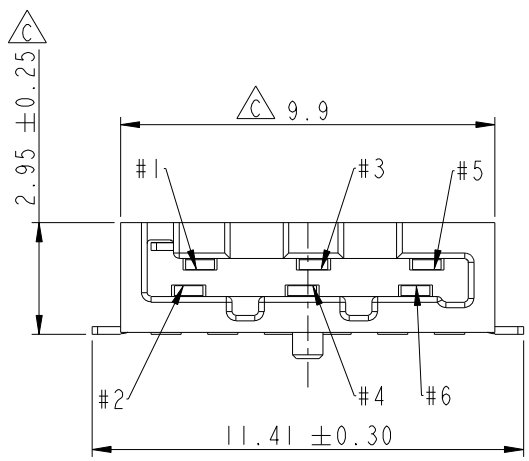

- Notes:
- * Important Dimension To Check.
 - * Housing: High temperature thermoplastic. UL94V-0, color is Natural white.
 - * Terminal: Copper Alloy, Gold Plated on contact area. Tin plated on solder tails.
 - * Solder Peg: Copper Alloy, Tin plated over Nickel.

UNIT: mm		
TOLERANCE		
.X	±0.25	
.XX	±0.1	
.XXX	±0.05	
ANGLES	±1°	

TITLE SSL-1.1 DC JACK CONNECTOR 6-POS. WITH POST, SMT TYPE			
SCALE	5:1	SIZE	A4
SHEET	1	OF	2
REV.	E	WC-REV.	C.3
QC: Inspection item			

Amphenol LTW
安費諾亮泰企業股份有限公司

ITEM NO.	SSL11-J6C00-000001	DRAWN BY	NianPing Yu	DATE	2019-08-29
DWG NO.	SSL11-J6C00-000001	CHECKED BY	Fisher Wang	DATE	2019-08-29
CUSTOMER	ALTW	APPROVED BY	Max Yang	DATE	2019-08-29

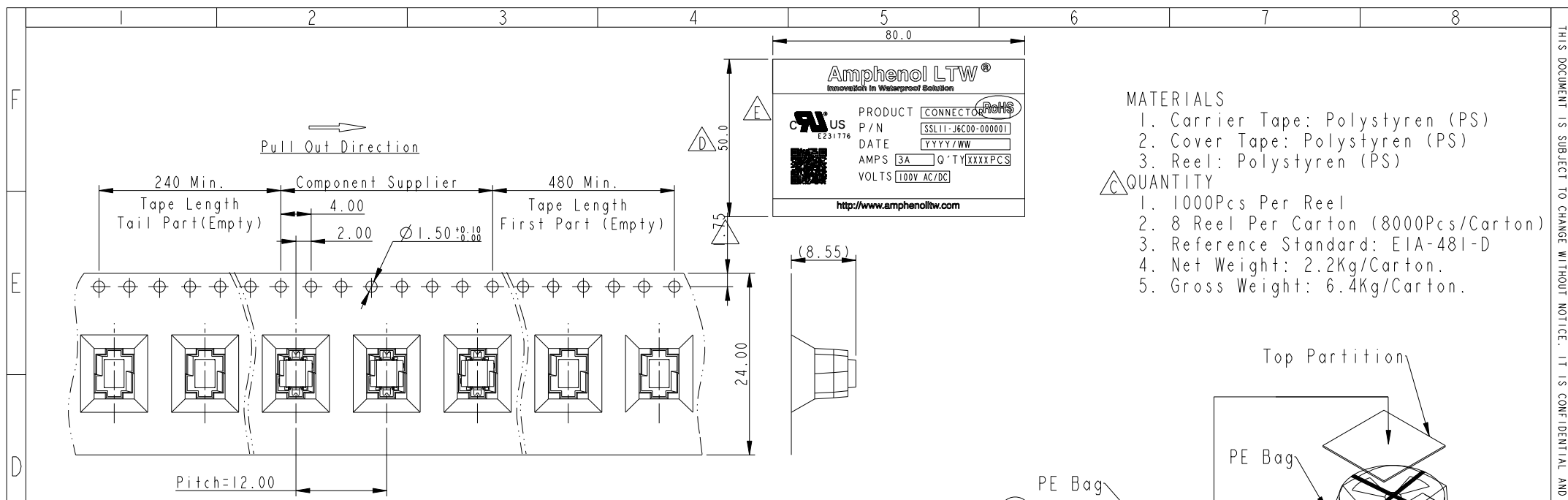

- MATERIALS**
- Carrier Tape: Polystyren (PS)
 - Cover Tape: Polystyren (PS)
 - Reel: Polystyren (PS)
- QUANTITY**
- 1000Pcs Per Reel
 - 8 Reel Per Carton (8000Pcs/Carton)
 - Reference Standard: EIA-481-D
 - Net Weight: 2.2Kg/Carton.
 - Gross Weight: 6.4Kg/Carton.

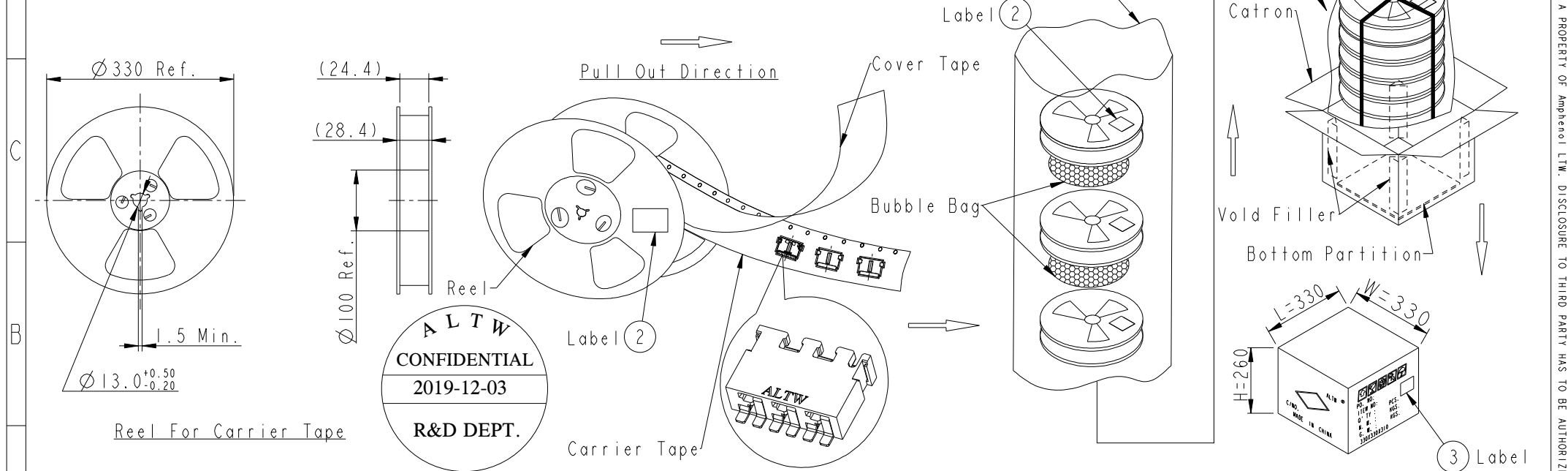

UNIT:mm TOLERANCE .X ±0.25 .XX ±0.1 .XXX ±0.05 ANGLES ±1°		TITLE SSL-1.1 DC JACK CONNECTOR 6-POS. WITH POST, SMT TYPE		Amphenol LTW 安費諾亮泰企業股份有限公司	ITEM NO SSL11-J6C00-000001	DRAWN BY NianPing Yu	DATE 2019-08-29
		SCALE 5:1	SIZE A4		SHEET 2 OF 2	DWG NO SSL11-J6C00-000001	CHECKED BY Fisher Wang
REV. E	WC-REV. C.3	QC : Inspection item		CUSTOMER ALTW	APPROVED BY Max Yang	DATE 2019-08-29	W10814-03-0001A2